

# “ECOL” Motors In Aluminum Housing

## FEATURES

- Energy savings, high efficiency
- High starting torque, lower starting current
- Versatile and easy to modify design adapts to a variety of applications
- Removable feet
- Option of terminal box location (top, left or right)
- Option of IE2, IE3, MEPS High and Premium Efficiency for IEC standards + NEMA EPACT and Premium Efficiency
- Contained total length is the same as or shorter than the current market standard
- Full use of the magnetization properties of cold rolled silicone steel in which the stator laminations are magnetized evenly to reduce temperature rise of the winding

## APPLICATIONS

- Pumps
- Waste water treatment plants
- Air compressors, fans
- Gear reducers and power transmission
- Pulp and paper mills
- Steel mill
- Conveyors, elevators
- Should be "Material handling equipment"
- Agricultural application
- Mining equipment
- Hydraulic equipment

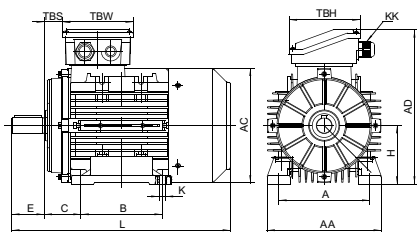
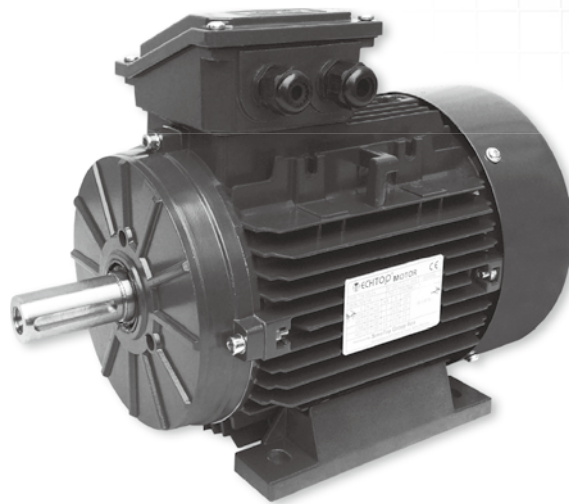

56-160 IM B3

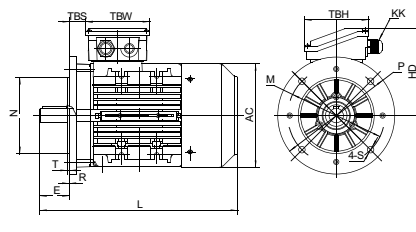

56-160 IM B5

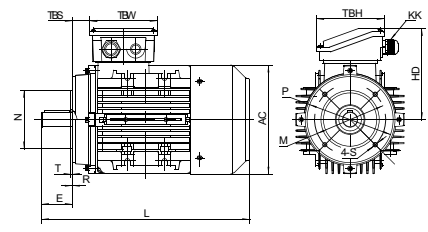

56-160 IM B14

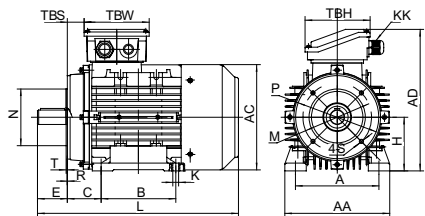

56-160 IM B34

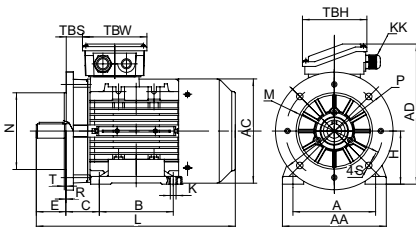

56-160 IM B35

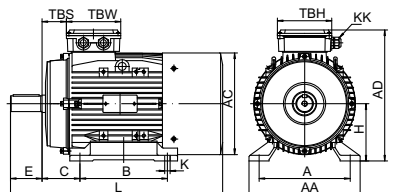
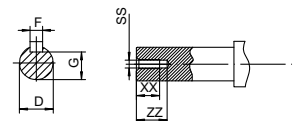

180-200 IM B3

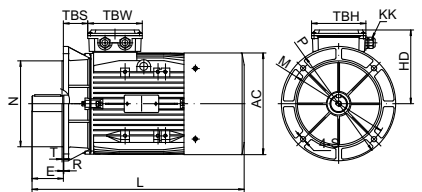

180-200 IM B5

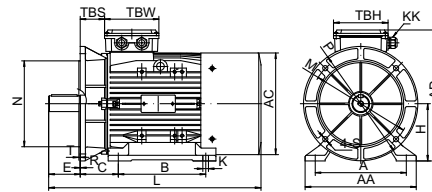

180-200 IM B35

## Overall & Installation Dimensions

FRAME	Bearings		KK	Foot Mounting				Shaft							General								
	Drive End	Non-Drive End		H	A	B	C	D	E	F	G	K	SS	XX	ZZ	AA	AD	HD	AC	L	TBS	TBW	TBH
TA 56	6201		1-M16*1.5	56	90	71	36	φ9	20	3	7.2	6×9	M4	9	12	112	151	95	φ110	195	16.5	83	83
TA 63	6201		1-M16*1.5	63	100	80	40	φ11	23	4	8.5	7×10	M4	10	14	124	170	107	φ122	215	10	98	98
TA 71	6202		1-M20*1.5	71	112	90	45	φ14	30	5	11	7×10	M5	12	17	140	186	115	φ138	245	16	98	98
TA 80	6204		1-M20*1.5	80	125	100	50	φ19	40	6	15.5	10×15	M6	16	21	160	214	134	φ157	277	26.5	109	109
TA 90S/L	6205		1-M20*1.5	90	140	100/125	56	φ24	50	8	20	10×15	M8	19	25	176	235	145	φ177	313/338	28.5	109	109
TA 100	6206		2-M20*1.5	100	160	140	63	φ28	60	8	24	12×16	M10	22	30	200	260	160	φ199	376	32	118	118
TA 112	6306	6206	2-M25*1.5	112	190	140	70	φ28	60	8	24	12×16	M10	22	30	224	283	171	φ220	397	33	118	118
TA 132S/M	6308	6208	2-M25*1.5	132	216	140/178	89	φ38	80	10	33	12×16	M12	28	37	260	323	191	φ261	460/498	36.5	118	118
TA 160M/L	6309	6209	2-M32*1.5	160	254	210/254	108	φ42	110	12	37	15×21	M16	36	45	314	391	231	φ814	616/660	64	148	148
TA 180	6311	6211	2-M32*1.5	180	279	241/279	121	φ48	110	14	42.5	15×25	M16	36	45	340	440	260	φ868	730	73	190	190
TA 200	6312	6212	2-M40*1.5	200	318	305	133	φ55	110	16	49	19×29	M20	42	53	390	460	260	φ868	745	85	190	190

FRAME	B5						B14						B5R						B14B						
	N	M	P	S	T	R	N	M	P	S	T	R	N	M	P	T	S	R	N	M	P	T	S	R	
TA 56	φ80	φ100	φ120	φ7	3	0	φ50	φ65	φ80	M5	2.5	0													
TA 63	φ95	φ115	φ140	φ10	3	0	φ60	φ75	φ90	M5	2.5	0													
TA 71	φ110	φ130	φ160	φ10	3.5	0	φ70	φ85	φ105	M6	2.5	0	φ95	φ115	φ140	3	φ10	0	φ95	φ115	φ140	3	M8	0	
TA 80	φ130	φ165	φ200	φ12	3.5	0	φ80	φ100	φ120	M6	3	0	φ110	φ130	φ160	3.5	φ10	0	φ110	φ130	φ160	3.5	M8	0	
TA 90S/L	φ130	φ165	φ200	φ12	3.5	0	φ95	φ115	φ140	M8	3	0	φ110	φ130	φ160	3.5	φ10	0	φ110	φ130	φ160	3.5	M8	0	
TA 100	φ180	φ215	φ250	φ15	4	0	φ110	φ130	φ160	M8	3.5	0	φ130	φ165	φ200	3.5	φ12	0	φ130	φ165	φ200	3.5	M10	0	
TA 112	φ180	φ215	φ250	φ15	4	0	φ110	φ130	φ160	M8	3.5	0	φ130	φ165	φ200	3.5	φ12	0	φ130	φ165	φ200	3.5	M10	0	
TA 132S/M	φ230	φ265	φ300	φ15	4	0	φ130	φ165	φ200	M10	3.5	0	φ180	φ215	φ250	4	φ15	0	φ180	φ215	φ250	4	M12	0	
TA 160M/L	φ250	φ300	φ350	φ19	5	0																			
TA 180	φ250	φ300	φ350	φ19	5	0																			
TA 200	φ300	φ350	φ400	φ19	5	0																			

# T1A Series IE1 Efficiency Motors Technical Data ( at 50Hz )

Model	Power	Current(A)			Current(A)			Current(A)			Speed (r/min)	Eff. (%)	Power factor (cos φ)	T <sub>start</sub> /T <sub>n</sub> (Times)	T <sub>max</sub> /T <sub>n</sub> (Times)	T <sub>min</sub> /T <sub>n</sub> (Times)	I <sub>st</sub> /I <sub>n</sub> (Times)	Noise dB(A)	W.T (kg)	Inertia kg*m <sup>2</sup>
		220V	380V	660V	230V	400V	690V	240V	415V	720V										
T1A 561-2	0.09	0.62	0.36	0.21	0.59	0.34	0.20	0.57	0.33	0.19	2710	53	0.72	2.2	2.3	2	4	58	2.8	0.000102
T1A 562-2	0.12	0.72	0.42	0.24	0.68	0.39	0.23	0.66	0.38	0.22	2700	61	0.72	2.2	2.3	2	4	58	3.2	0.000128
T1A 563-2	0.18	1.00	0.58	0.33	0.95	0.55	0.32	0.92	0.53	0.31	2710	63	0.75	2.2	2.4	1.6	6	61	3.5	0.000142
T1A 631-2	0.18	1.00	0.58	0.33	0.95	0.55	0.32	0.92	0.53	0.31	2710	63	0.75	2.2	2.4	1.6	6	61	3.7	0.000150
T1A 632-2	0.25	1.30	0.75	0.43	1.23	0.71	0.41	1.19	0.69	0.40	2710	65	0.78	2.2	2.4	1.6	6	61	4.2	0.000171
T1A 633-2	0.37	1.92	1.11	0.64	1.82	1.05	0.61	1.76	1.02	0.59	2710	65	0.78	2.2	2.4	1.6	6	62	4.7	0.000203
T1A 711-2	0.37	1.76	1.02	0.59	1.67	0.97	0.56	1.61	0.93	0.54	2730	70	0.79	2.2	2.4	1.6	6	64	5.34	0.000314
T1A 712-2	0.55	2.58	1.49	0.86	2.45	1.42	0.82	2.36	1.36	0.79	2760	71	0.79	2.2	2.4	1.6	6	64	6.14	0.000384
T1A 713-2	0.75	3.34	1.93	1.11	3.18	1.83	1.06	3.06	1.77	1.02	2730	72	0.82	2.2	2.4	1.5	6	65	7.1	0.000475
T1A 801-2	0.75	3.44	1.98	1.15	3.26	1.88	1.09	3.15	1.82	1.05	2860	69.2	0.83	2.1	2.5	1.5	5.7	67	8.15	0.000896
T1A 802-2	1.1	4.41	2.55	1.47	4.19	2.42	1.40	4.04	2.33	1.35	2870	79	0.83	2.6	2.8	1.8	6.5	67	9.7	0.001124
T1A 803-2	1.5	5.87	3.39	1.96	5.58	3.22	1.86	5.38	3.10	1.79	2870	81	0.83	2.7	2.8	1.8	6.8	70	11.2	0.001351
T1A 90S-2	1.5	5.94	3.43	1.98	5.65	3.26	1.88	5.44	3.14	1.81	2880	80	0.83	2.3	2.8	1.4	6.6	72	12.3	0.001856
T1A 90L1-2	2.2	8.25	4.77	2.75	7.84	4.53	2.61	7.56	4.36	2.52	2880	83.5	0.84	2.6	2.7	1.8	7.1	72	14.9	0.002306
T1A 90L2-2	3	10.8	6.24	3.60	10.3	5.92	3.42	9.89	5.71	3.30	2900	86	0.85	2.9	3	1.9	8.1	74	17.4	0.002966
T1A 100L1-2	3	11.3	6.54	3.77	10.8	6.21	3.59	10.4	5.99	3.46	2900	83	0.84	2.7	3.2	2.1	7.7	76	20.1	0.003776
T1A 100L2-2	4	15.0	8.67	5.00	14.3	8.23	4.75	13.7	7.93	4.58	2890	84.5	0.83	3.1	3.6	2.8	8.1	77	23	0.004664
T1A 100L3-2	5.5	18.7	10.8	6.23	17.8	10.25	5.92	17.1	9.88	5.70	2900	88	0.88	3.3	3.6	2.5	10.1	78	26	0.005907
T1A 112M1-2	4	14.2	8.2	4.75	13.5	7.81	4.51	13.0	7.53	4.34	2910	85	0.87	2.8	3.6	1.7	9.2	77	26.3	0.006311
T1A 112M2-2	5.5	19.0	11.0	6.34	18.1	10.4	6.02	17.4	10.1	5.80	2900	86.5	0.88	3	3.8	2.2	9.8	78	31.2	0.007796
T1A 112M3-2	7.5	25.8	14.9	8.59	24.5	14.1	8.16	23.6	13.6	7.87	2910	88	0.87	3.8	4.2	2.7	10.3	80	37	0.009833
T1A 132S1-2	5.5	19.7	11.4	6.57	18.7	10.8	6.24	18.0	10.4	6.02	2890	84.4	0.87	2.2	2.8	2.2	6.8	80	37.6	0.012058
T1A 132S2-2	7.5	25.8	14.9	8.59	24.5	14.1	8.16	23.6	13.6	7.87	2890	88	0.87	2.7	3.2	2.5	8.2	80	43	0.015212
T1A 132M1-2	9.2	30.6	17.6	10.2	29.0	16.8	9.68	28.0	16.2	9.33	2910	88	0.9	3.1	3.8	1.7	9.7	81	48.4	0.017834
T1A 132M2-2	11	36.5	21.1	12.2	34.7	20.0	11.6	33.5	19.3	11.2	2920	89	0.89	3.3	4	1.8	10.7	83	54.2	0.020357
T1A 132M3-2	15	50.4	29.1	16.8	47.9	27.7	16.0	46.2	26.7	15.4	2940	91	0.86	4	4.5	2.5	14	86	72	0.028557
T1A 160M1-2	11	38.3	22.1	12.8	36.4	21.0	12.1	35.1	20.2	11.7	2940	90	0.84	2.6	3.1	1.5	7.9	86	72	0.044380
T1A 160M2-2	15	51.4	29.7	17.1	48.9	28.2	16.3	47.1	27.2	15.7	2950	90.3	0.85	2.8	3.3	1.4	8.6	86	82	0.055805
T1A 160L1-2	18.5	62.9	36.3	21.0	59.8	34.5	19.9	57.6	33.3	19.2	2950	91	0.85	3	3.4	1.6	9.3	86	94.1	0.065593
T1A 160L2-2	22	73.7	42.6	24.6	70.0	40.4	23.4	67.5	39.0	22.5	2950	91.3	0.86	3.2	3.5	1.7	9.9	91	104.5	0.077018
T1A 561-4	0.06	0.56	0.33	0.19	0.54	0.31	0.18	0.52	0.30	0.17	1360	50	0.56	2.3	2.4	2	4	50	2.9	0.000190
T1A 562-4	0.09	0.77	0.45	0.26	0.73	0.42	0.24	0.71	0.41	0.24	1360	52	0.59	2.3	2.4	2	4	50	3.3	0.000240
T1A 563-4	0.12	0.95	0.55	0.32	0.90	0.52	0.30	0.87	0.50	0.29	1360	52	0.64	2.2	2.4	2	4	52	3.7	0.000265
T1A 631-4	0.12	0.95	0.55	0.32	0.90	0.52	0.30	0.87	0.50	0.29	1360	52	0.64	2.2	2.4	2	4	52	3.7	0.000273
T1A 632-4	0.18	1.28	0.74	0.43	1.21	0.70	0.40	1.17	0.68	0.39	1310	57	0.65	2.2	2.4	2	4	52	4.4	0.000338
T1A 633-4	0.25	1.66	0.96	0.55	1.58	0.91	0.53	1.52	0.88	0.51	1340	60	0.66	2.2	2.2	2	4	54	5	0.000408
T1A 711-4	0.25	1.52	0.88	0.51	1.45	0.84	0.48	1.39	0.81	0.46	1350	60	0.72	2.2	2.4	1.7	6	55	5.06	0.000561
T1A 712-4	0.37	2.02	1.17	0.67	1.92	1.11	0.64	1.85	1.07	0.62	1370	65	0.74	2.2	2.4	1.7	6	55	5.96	0.000714
T1A 713-4	0.55	2.92	1.69	0.97	2.78	1.60	0.93	2.68	1.55	0.89	1380	66	0.75	2.2	2.4	1.7	6	57	7.06	0.000919
T1A 801-4	0.55	2.64	1.53	0.88	2.51	1.45	0.84	2.42	1.40	0.81	1420	73	0.75	2	2.3	1.6	4.8	57	8.3	0.001453
T1A 802-4	0.75	3.39	1.96	1.13	3.22	1.86	1.08	3.11	1.79	1.04	1410	76.5	0.76	2	2.4	1.7	5	58	9.8	0.001690
T1A 803-4	1.1	4.91	2.84	1.64	4.67	2.70	1.56	4.50	2.60	1.50	1390	77.5	0.76	2.3	2.4	2	5	61	11.2	0.002166
T1A 90S-4	1.1	4.88	2.82	1.63	4.64	2.68	1.55	4.47	2.58	1.49	1400	78	0.76	2.1	2.3	1.9	5	61	12.3	0.002675
T1A 90L1-4	1.5	6.25	3.61	2.08	5.94	3.43	1.98	5.72	3.30	1.91	1410	81	0.78	2.6	2.4	2.1	5.7	61	15.1	0.003519
T1A 90L2-4	2.2	8.72	5.03	2.91	8.28	4.78	2.76	7.98	4.61	2.66	1420	83	0.8	2.7	2.3	2.1	6.2	64	17.78	0.004685
T1A 100L1-4	2.2	9.42	5.44	3.14	8.95	5.16	2.98	8.62	4.98	2.87	1430	80.9	0.76	2.2	2.8	1.9	6	64	20	0.006775
T1A 100L2-4	3	11.4	6.58	3.80	10.8	6.25	3.61	10.4	6.02	3.48	1430	84.5	0.82	2.5	2.8	2.1	6.7	64	24	0.008424
T1A 100L3-4	4	16.1	9.28	5.36	15.3	8.81	5.09	14.7	8.49	4.90	1430	84	0.78	2.7	3	2.3	6.9	65	28.2	0.010733
T1A 112M1-4	4	15.8	9.11	5.26	15.0	8.66	5.00	14.5	8.34	4.82	1440	85.5	0.78	2.3	3.3	2.1	7.8	65	29.8	0.013228
T1A 112M2-4	5.5	21.7	12.5	7.24	20.6	11.9	6.88	19.9	11.5	6.63	1450	86.5	0.77	3.4	3.5	2.6	8.6	71	36	0.016839
T1A 132S-4	5.5	20.5	11.9	6.84	19.5	11.3	6.50	18.8	10.9	6.26	1450	86	0.82	1.8	2.9	1.7	7.1	71	42	0.028012
T1A 132M1-4	7.5	28.2	16.3	9.40	26.8	15.5	8.93	25.8	14.9	8.61	1450	87.5	0.8	2.9	3.3	1.9	8.4	71	52.6	0.037145
T1A 132M2-4	9.2	33.8	19.5	11.3	32.1	18.5	10.7	30.9	17.9	10.3	1450	88.5	0.81	3.1	3.4	1.7	8.9	74	55	0.043597
T1A 132M3-4	11	40.0	23.1	13.3	38.0	21.9	12.7	36.6	21.1	12.2	1450	89.4	0.81	3.5	3.5	1.7	9.4	75	64	0.051339
T1A 160M-4	11	40.7	23.5	13.6	38.6	22.3	12.9	37.2	21.5	12.4	1460	89	0.8	2.3	2.8	1.3	6.8	75	74	0.080254
T1A 160L1-4	15	53.2	30.7	17.7	50.5	29.2	16.8	48.7	28.1	16.2	1460	90.5	0.82	2.4	2.6	1.4	7.5	75	90.3	0.105640
T1A 160L2-4	18.5	64.5	37.3	21.5	61.3	35.4	20.4	59.1	34.1	19.7	1460	90.9	0.83	2.4	2.5	1.4	7.6	78	104	0.127619
T1A 160L3-4	22	77.2	44.6	25.8	73.4	42.4	24.5	70.7	40.8	23.6	1460	91.4	0.82	2.8	2.7	1.5	8.8	80	118.5	0.149598

# T1A Series IE1 Efficiency Motors Technical Data ( at 50Hz )

Model	Power	Current(A)			Current(A)			Current(A)			Speed (r/min)	Eff. (%)	Power factor (cos φ)	T <sub>star</sub> /T <sub>n</sub> (Times)	T <sub>max</sub> /T <sub>n</sub> (Times)	T <sub>min</sub> /T <sub>n</sub> (Times)	I <sub>s</sub> /I <sub>n</sub> (Times)	Noise dB(A)	W.T (kg)	Inertia kg*m <sup>2</sup>	
		220V	380V	660V	230V	400V	690V	240V	415V	720V											
T1A 631-6	0.09	0.92	0.53	0.31	0.88	0.51	0.29	0.85	0.49	0.28	840	42	0.61	2	2	1.5	3.5	50	4.2	0.000418	
T1A 632-6	0.12	1.13	0.65	0.38	1.08	0.62	0.36	1.04	0.60	0.35	850	45	0.62	2	2	1.5	3.5	50	4.5	0.000517	
T1A 711-6	0.18	1.28	0.74	0.43	1.22	0.70	0.41	1.17	0.68	0.39	880	56	0.66	1.6	1.7	1.5	4	52	5.6	0.000841	
T1A 712-6	0.25	1.59	0.92	0.53	1.51	0.87	0.50	1.46	0.84	0.49	900	59	0.7	2.1	2.2	1.5	4	52	6	0.000965	
T1A 713-6	0.37	2.31	1.34	0.77	2.20	1.27	0.73	2.12	1.22	0.71	890	61	0.69	2	2.1	1.5	4	54	6.8	0.001150	
T1A 801-6	0.37	2.42	1.40	0.81	2.30	1.33	0.77	2.21	1.28	0.74	910	61	0.66	1.9	2.2	1.8	3.2	56	8	0.001596	
T1A 802-6	0.55	3.40	1.96	1.13	3.23	1.86	1.08	3.11	1.80	1.04	910	65.5	0.65	2.1	2.3	1.9	3.5	56	9.1	0.002041	
T1A 803-6	0.75	4.06	2.34	1.35	3.85	2.23	1.28	3.72	2.14	1.24	910	70.5	0.69	2.1	2.2	1.9	3.8	58	10.6	0.002634	
T1A 90S-6	0.75	4.06	2.34	1.35	3.86	2.23	1.29	3.72	2.15	1.24	940	71.5	0.68	1.8	2.2	1.5	4.1	59	11.5	0.003266	
T1A 90L-6	1.1	5.97	3.45	1.99	5.67	3.27	1.89	5.46	3.15	1.82	930	73.5	0.66	1.9	2.3	1.8	4.1	59	14.5	0.004281	
T1A 90L2-6	1.5	7.63	4.40	2.54	7.25	4.18	2.42	6.98	4.03	2.33	930	75	0.69	2	2.2	1.9	4.3	61	15.5	0.005487	
T1A 100L-6	1.5	7.43	4.29	2.48	7.06	4.08	2.35	6.80	3.93	2.27	940	77	0.69	1.9	2.6	1.8	4.6	61	18.7	0.007543	
T1A 100L2-6	2.2	9.71	5.61	3.24	9.22	5.33	3.07	8.89	5.13	2.96	940	79.5	0.75	2	2.3	1.8	5.1	64	22.8	0.009935	
T1A 112M1-6	2.2	10.6	6.11	3.53	10.1	5.80	3.35	9.69	5.59	3.23	945	79.3	0.69	1.9	2.3	1.8	4.8	64	24.5	0.013950	
T1A 112M2-6	3	14.1	8.16	4.71	13.4	7.75	4.47	12.9	7.47	4.31	950	81	0.69	1.9	2.8	1.8	5	64	28.5	0.017675	
T1A 132S-6	3	13.3	7.67	4.43	12.6	7.29	4.21	12.2	7.03	4.06	960	82.5	0.72	1.9	2.5	1.4	5.7	64	36.4	0.030457	
T1A 132M1-6	4	17.1	9.85	5.69	16.2	9.36	5.40	15.6	9.02	5.21	965	84.5	0.73	2	2.6	1.5	5.9	68	42.2	0.037251	
T1A 132M2-6	5.5	23.5	13.6	7.84	22.3	12.9	7.45	21.5	12.4	7.18	950	85.5	0.72	2.1	2.7	1.6	6.2	68	51.4	0.048966	
T1A 132M3-6	7.5	30.2	17.5	10.1	28.7	16.6	9.58	27.7	16.0	9.23	965	87	0.75	2.7	2.9	2	7.3	68	62.6	0.062355	
T1A 160M-6	7.5	30.2	17.5	10.1	28.7	16.6	9.58	27.7	16.0	9.23	965	87	0.75	2.4	2.9	1.7	6.7	68	68.3	0.086226	
T1A 160L-6	11	43.2	24.9	14.4	41.1	23.7	13.7	39.6	22.8	13.2	965	87	0.77	2.5	2.7	1.5	6.9	73	86	0.116874	
T1A 711-8	0.09	0.97	0.56	0.32	0.92	0.53	0.31	0.88	0.51	0.29	680	43	0.57	2.4	2.5	2.3	2.5	50	5.6	0.000717	
T1A 712-8	0.12	1.14	0.66	0.38	1.08	0.62	0.36	1.04	0.60	0.35	690	49.5	0.56	2.7	2.8	2.6	3	50	6	0.000841	
T1A 801-8	0.18	1.48	0.86	0.49	1.41	0.81	0.47	1.36	0.79	0.45	690	55	0.58	2.2	2.4	2	3	52	8.3	0.002021	
T1A 802-8	0.25	1.94	1.12	0.65	1.84	1.06	0.61	1.78	1.03	0.59	690	58.5	0.58	2.3	2.4	2	3.1	52	9.3	0.002323	
T1A 90S-8	0.37	2.58	1.49	0.86	2.45	1.41	0.82	2.36	1.36	0.79	710	64	0.59	1.9	2.3	1.7	3.3	56	11.38	0.003266	
T1A 90L-8	0.55	3.84	2.22	1.28	3.65	2.11	1.22	3.52	2.03	1.17	705	65	0.58	1.9	2.3	1.7	3.4	56	14	0.004281	
T1A 90L2-8	0.75	4.69	2.71	1.56	4.45	2.57	1.49	4.29	2.48	1.43	700	69	0.61	1.8	2.1	1.8	3.5	59	15.5	0.004884	
T1A 100L1-8	0.75	4.43	2.56	1.48	4.21	2.43	1.40	4.06	2.34	1.35	685	68.5	0.65	1.9	1.8	2.2	3.6	59	17.6	0.006346	
T1A 100L2-8	1.1	6.09	3.52	2.03	5.79	3.34	1.93	5.58	3.22	1.86	690	72	0.66	1.9	2.1	1.8	3.5	59	20	0.008340	
T1A 112M-8	1.5	7.87	4.54	2.62	7.48	4.32	2.49	7.21	4.16	2.40	700	76	0.66	1.8	2.3	1.8	4	61	25.3	0.013950	
T1A 132S-8	2.2	10.6	6.13	3.54	10.1	5.83	3.36	9.73	5.62	3.24	715	79	0.69	1.9	2.4	1.7	4.9	64	39.6	0.032131	
T1A 132M-8	3	13.9	8.04	4.64	13.2	7.64	4.41	12.7	7.36	4.25	715	81	0.7	2	2.5	1.8	5.1	64	47.4	0.040598	
T1A 160M1-8	4	18.3	10.6	6.11	17.4	10.1	5.81	16.8	9.70	5.60	715	82	0.7	1.8	2.3	1.6	4.6	68	59.8	0.071036	
T1A 160M2-8	5.5	24.8	14.3	8.25	23.5	13.6	7.84	22.7	13.1	7.56	710	83.5	0.7	1.9	2.4	1.8	4.8	68	69	0.086226	
T1A 160L-8	7.5	33.0	19.0	11.0	31.3	18.1	10.4	30.2	17.4	10.1	715	85.5	0.7	2.5	2.8	2	5.7	68	84.8	0.113076	

# T2A Series IE2 Efficiency Motors Technical Data ( at 50Hz )

Model	Power	Current(A)			Current(A)			Current(A)			Speed (r/min)	Eff. (%)	Power factor (cos φ)	T <sub>start</sub> /T <sub>n</sub> (Times)	T <sub>max</sub> /T <sub>n</sub> (Times)	T <sub>min</sub> /T <sub>n</sub> (Times)	I <sub>s</sub> /I <sub>n</sub> (Times)	Noise dB(A)	W.T (kg)	Inertia kg*m <sup>2</sup>
		220V	380V	660V	230V	400V	690V	240V	415V	720V										
T2A 801-2	0.75	3.15	1.82	1.05	2.99	1.73	1.00	2.88	1.66	0.96	2840	77.4	0.81	2.6	2.8	2.2	6.1	67	8.4	0.000896
T2A 802-2	1.1	4.43	2.56	1.48	4.21	2.43	1.40	4.06	2.34	1.35	2860	79.6	0.82	2.6	2.6	1.8	7	67	9.8	0.001124
T2A 803-2	1.5	5.78	3.34	1.93	5.49	3.17	1.83	5.29	3.06	1.76	2880	81.3	0.84	2.9	3.1	2	7.4	70	11.3	0.001427
T2A 90S-2	1.5	5.92	3.42	1.97	5.63	3.25	1.88	5.42	3.13	1.81	2880	81.3	0.82	2.8	3	2	7.2	72	12.4	0.001856
T2A 90L1-2	2.2	8.38	4.84	2.79	7.96	4.60	2.66	7.68	4.43	2.56	2890	83.2	0.83	2.8	3.1	1.4	7.6	72	15	0.002306
T2A 90L2-2	3	11.0	6.34	3.66	10.4	6.02	3.48	10.05	5.80	3.35	2880	84.6	0.85	3.4	3.3	2.3	7.9	74	17.2	0.002966
T2A 100L1-2	3	10.7	6.19	3.58	10.2	5.88	3.40	9.82	5.67	3.27	2910	84.6	0.87	3.1	3.5	2.6	8.8	76	22	0.004131
T2A 100L2-2	4	14.1	8.14	4.70	13.4	7.73	4.47	12.9	7.46	4.30	2910	85.8	0.87	3.7	4.2	3.8	9.9	77	25.8	0.005197
T2A 112M1-2	4	13.8	7.96	4.60	13.1	7.56	4.37	12.6	7.29	4.21	2920	85.8	0.89	3.3	3.6	2	9.6	77	26.7	0.006311
T2A 112M2-2	5.5	19.1	11.0	6.37	18.2	10.5	6.06	17.5	10.1	5.84	2920	87	0.87	3.4	4.1	2.8	10.2	78	32.5	0.008057
T2A 132S1-2	5.5	18.7	10.8	6.23	17.8	10.3	5.92	17.1	9.9	5.71	2920	87	0.89	2.4	3.4	1.9	8.3	80	39.7	0.013319
T2A 132S2-2	7.5	25.2	14.5	8.39	23.9	13.8	7.97	23.0	13.3	7.68	2920	88.1	0.89	3.1	3.7	2	10.3	80	47.3	0.016473
T2A 132M1-2	9.2	30.7	17.7	10.2	29.1	16.8	9.71	28.1	16.2	9.36	2920	88.7	0.89	3.4	4.1	1.4	10.8	81	52	0.017834
T2A 132M2-2	11	36.0	20.8	12.0	34.2	19.7	11.4	32.9	19.0	11.0	2930	89.4	0.9	4	3.9	1.7	12.7	83	58.5	0.021619
T2A 132M3-2	15	48.6	28.0	16.2	46.1	26.6	15.4	44.5	25.7	14.8	2940	90.3	0.9	3.7	4.3	1.7	13.6	86	74	0.028557
T2A 160M1-2	11	36.4	21.0	12.1	34.6	20.0	11.5	33.3	19.2	11.1	2950	89.4	0.89	2.6	3.4	1.5	8.4	86	79	0.050092
T2A 160M2-2	15	48.6	28.0	16.2	46.1	26.6	15.4	44.5	25.7	14.8	2950	90.3	0.9	2.6	3.4	1.8	9.4	86	91	0.065326
T2A 160L1-2	18.5	59.5	34.4	19.8	56.5	32.6	18.8	54.5	31.5	18.2	2950	90.9	0.9	2.6	3.2	1.8	9.4	86	101	0.077018
T2A 160L2-2	22	69.7	40.2	23.2	66.2	38.2	22.1	63.8	36.8	21.3	2950	91.3	0.91	3.1	3.6	1.8	10.6	91	112.5	0.090348
T2A 802-4	0.75	3.49	2.02	1.16	3.32	1.92	1.11	3.20	1.85	1.07	1420	79.6	0.71	2.7	2.9	2.4	5.7	58	10.4	0.001928
T2A 803-4	1.1	4.94	2.85	1.65	4.69	2.71	1.56	4.52	2.61	1.51	1420	81.4	0.72	3.1	3.1	2.5	5.9	61	12.3	0.002522
T2A 90S-4	1.1	4.81	2.77	1.60	4.57	2.64	1.52	4.40	2.54	1.47	1440	81.4	0.74	2.9	3.1	2.2	6.8	61	13.8	0.003342
T2A 90L1-4	1.5	6.44	3.72	2.15	6.12	3.53	2.04	5.90	3.41	1.97	1440	82.8	0.74	3.1	3.2	2.2	6.5	61	16.1	0.004185
T2A 90L2-4	2.2	9.16	5.29	3.05	8.70	5.02	2.90	8.38	4.84	2.80	1430	84.3	0.75	3.4	2.4	2.2	7.1	64	18.8	0.005352
T2A 100L1-4	2.2	8.38	4.84	2.79	7.96	4.59	2.65	7.67	4.43	2.56	1440	84.3	0.82	2.4	2.9	2	6.6	64	22	0.007765
T2A 100L2-4	3	11.5	6.66	3.85	11.0	6.33	3.66	10.6	6.10	3.52	1450	85.5	0.8	2.3	3.2	2.4	7.6	64	25.8	0.009743
T2A 100L3-4	4	15.2	8.77	5.06	14.4	8.33	4.81	13.9	8.03	4.64	1440	86.6	0.8	2.8	3.2	2.3	7.2	65	28.6	0.011063
T2A 112M1-4	4	14.8	8.56	4.94	14.1	8.13	4.69	13.6	7.84	4.52	1440	86.6	0.82	2.5	3.3	2.3	7.9	65	31.4	0.013744
T2A 112M2-4	5.5	20.6	11.9	6.88	19.6	11.3	6.53	18.9	10.9	6.30	1440	87.7	0.8	3.7	3.6	3.1	8.3	71	36.7	0.017355
T2A 132S-4	5.5	19.9	11.5	6.63	18.9	10.9	6.30	18.2	10.5	6.07	1460	87.7	0.83	2.1	3.5	1.9	8.6	71	44.3	0.030593
T2A 132M1-4	7.5	26.8	15.5	8.94	25.5	14.7	8.49	24.5	14.2	8.18	1460	88.7	0.83	2.7	3.2	1.7	8.9	71	54.5	0.039726
T2A 132M2-4	9.2	31.9	18.4	10.6	30.3	17.5	10.1	29.2	16.9	9.7	1460	89.2	0.85	2.9	3.2	1.7	8.7	74	56.6	0.046178
T2A 132M3-4	11	37.9	21.9	12.6	36.0	20.8	12.0	34.7	20.0	11.6	1460	89.8	0.85	3.3	3.6	1.4	9.3	75	68	0.053920
T2A 160M-4	11	38.8	22.4	12.9	36.9	21.3	12.3	35.6	20.5	11.9	1460	89.8	0.83	2.5	2.7	1.7	7	75	82	0.089674
T2A 160L1-4	15	51.9	29.9	17.3	49.3	28.4	16.4	47.5	27.4	15.8	1470	90.6	0.84	2.5	2.8	1.6	8.3	75	103	0.118199
T2A 160L2-4	18.5	63.5	36.7	21.2	60.4	34.9	20.1	58.2	33.6	19.4	1470	91.2	0.84	2.7	3	1.7	8.8	78	115	0.137038
T2A 803-6	0.75	3.88	2.24	1.29	3.69	2.13	1.23	3.55	2.05	1.18	920	75.9	0.67	2.7	2.6	2.5	4.2	58	11.7	0.003079
T2A 90S-6	0.75	4.00	2.31	1.33	3.80	2.19	1.27	3.66	2.11	1.22	940	75.9	0.65	2.2	2.5	1.9	4.5	59	12.6	0.003467
T2A 90L-6	1.1	5.37	3.10	1.79	5.10	2.95	1.70	4.92	2.84	1.64	950	78.1	0.69	2	2.4	1.8	4.9	59	15.2	0.004884
T2A 90L2-6	1.5	7.27	4.20	2.42	6.91	3.99	2.30	6.66	3.85	2.22	945	79.8	0.68	2.7	3	2.5	5.1	61	18.2	0.006292
T2A 100L-6	1.5	6.68	3.86	2.23	6.35	3.67	2.12	6.12	3.53	2.04	950	79.8	0.74	1.7	2.2	1.6	4.8	61	20.7	0.008340
T2A 100L2-6	2.2	9.83	5.68	3.28	9.34	5.39	3.11	9.00	5.20	3.00	950	81.8	0.72	2.5	2.7	2.1	5.5	64	25	0.011529
T2A 112M-6	2.2	9.70	5.60	3.23	9.21	5.32	3.07	8.88	5.13	2.96	955	81.8	0.73	2.1	2.7	1.8	5.5	64	26	0.015440
T2A 112M2-6	3	13.2	7.60	4.39	12.5	7.22	4.17	12.1	6.96	4.02	955	83.3	0.72	2.3	2.8	2.1	5.7	64	31	0.019165
T2A 132S-6	3	12.5	7.20	4.16	11.8	6.84	3.95	11.4	6.59	3.81	960	83.3	0.76	1.6	2.4	1.5	5.6	64	37.8	0.032131
T2A 132M1-6	4	16.8	9.71	5.61	16.0	9.22	5.32	15.4	8.89	5.13	965	84.6	0.74	2	2.6	1.6	5.9	68	43.8	0.038925
T2A 132M2-6	5.5	22.4	13.0	7.48	21.3	12.3	7.11	20.5	11.9	6.85	965	86	0.75	2.4	2.6	1.8	6.6	68	51.1	0.048966
T2A 132M3-6	7.5	29.8	17.2	9.93	28.3	16.3	9.43	27.3	15.7	9.09	970	87.2	0.76	3.1	3.2	1.9	7.9	68	66	0.065702
T2A 160M-6	7.5	29.4	17.0	9.80	27.9	16.1	9.31	26.9	15.5	8.97	965	87.2	0.77	2.5	2.9	1.8	6.9	68	74	0.093821
T2A 160L-6	11	42.9	24.8	14.3	40.8	23.6	13.6	39.3	22.7	13.1	970	88.7	0.76	2.2	2.3	1.3	6.5	73	93	0.128267
T2A 160L2-6	15	57.2	33.0	19.1	54.3	31.3	18.1	52.3	30.2	17.4	965	89.7	0.77	3.1	3	2.2	8.3	79	116	0.170040

IEC MOTOR

FIRE PUMP MOTOR

GOST MOTOR

NEMA MOTOR

DC MOTOR

EC MOTOR

# T3A Series IE3 Efficiency Motors Technical Data ( at 50Hz )

Model	Power	Current(A)			Current(A)			Current(A)			Speed (r/min)	Eff.			Power Factor	Tstart/Tn (Times)	Tmax/Tn (Times)	Tmin/Tn (Times)	Is/In (Times)	Noise dB(A)	W.T (kg)	Inertia kg*m <sup>2</sup>
		220V	380V	660V	230V	400V	690V	240V	415V	720V		100%	75%	50%								
T3A 631-2	0.18	0.96	0.55	0.32	0.91	0.53	0.30	0.88	0.51	0.29	2850	65.9	63.5	56.2	0.75	2	2.5	1.6	4.7	61	3.6	0.000231
T3A 632-2	0.25	1.21	0.70	0.40	1.15	0.66	0.38	1.11	0.64	0.37	2840	69.7	68.4	62.5	0.78	2.5	2.7	2	5.2	61	3.9	0.000255
T3A 711-2	0.37	1.74	1.00	0.58	1.65	0.95	0.55	1.59	0.92	0.53	2860	73.8	72.4	66.5	0.76	2.5	2.8	1.8	5.6	64	5.2	0.000369
T3A 712-2	0.55	2.33	1.34	0.78	2.21	1.28	0.74	2.13	1.23	0.71	2860	77.8	63.5	56.2	0.80	3.1	3.1	2	6.5	64	6.2	0.000495
T3A 713-2	0.75	2.98	1.72	0.99	2.83	1.64	0.94	2.73	1.58	0.91	2870	80.7	80.8	78.2	0.82	3	3.2	2.2	7.1	65	7.1	0.000606
T3A 801-2	0.75	3.02	1.74	1.01	2.87	1.66	0.96	2.76	1.60	0.92	2890	80.7	80.3	77.2	0.81	3.1	3.2	2.3	7.4	67	8.9	0.000972
T3A 802-2	1.1	4.22	2.43	1.41	4.01	2.31	1.34	3.86	2.23	1.29	2890	82.7	82.5	79.9	0.83	3.4	3.4	2	8.7	67	10.6	0.001275
T3A 803-2	1.5	5.79	3.34	1.93	5.50	3.17	1.83	5.30	3.06	1.77	2910	84.2	83.9	81.5	0.81	4	4	2.2	9.6	70	12.5	0.001654
T3A 90S-2	1.5	5.72	3.30	1.91	5.43	3.14	1.81	5.24	3.02	1.75	2900	84.2	83.8	81.4	0.82	3.5	3.7	2.1	8.3	72	14	0.002186
T3A 90L1-2	2.2	8.22	4.75	2.74	7.81	4.51	2.60	7.53	4.35	2.51	2910	85.9	86.1	84.7	0.82	3.1	3.5	2.2	8.1	72	16.3	0.002636
T3A 90L2-2	3	11.3	6.54	3.78	10.8	6.21	3.59	10.37	5.99	3.46	2910	87.1	87.1	84.2	0.80	4	4.1	2.6	9.6	74	18.5	0.003406
T3A 100L1-2	3	10.2	5.88	3.39	9.7	5.59	3.23	9.33	5.38	3.11	2910	87.1	87.5	86.3	0.89	3.2	3.6	2.6	9.4	76	23.7	0.004842
T3A 100L2-2	4	13.3	7.66	4.43	12.6	7.28	4.20	12.2	7.02	4.05	2910	88.1	88.7	88.1	0.90	3.3	3.6	2.3	10.1	77	27.6	0.005907
T3A 112M1-2	4	13.1	7.58	4.38	12.5	7.20	4.16	12.0	6.94	4.01	2920	88.1	88.2	87.0	0.91	3.4	3.9	2.4	10.5	77	30.1	0.007505
T3A 112M2-2	5.5	17.8	10.3	5.94	16.9	9.78	5.65	16.3	9.43	5.44	2920	89.2	89.6	89.1	0.91	3.3	4.2	2.9	11.9	78	35.7	0.009251
T3A 132S1-2	5.5	18.2	10.5	6.08	17.3	10.0	5.77	16.7	9.64	5.56	2930	89.2	89.4	88.2	0.89	3.2	4	2.5	10	80	43.4	0.015212
T3A 132S2-2	7.5	24.3	14.1	8.11	23.1	13.4	7.71	22.3	12.9	7.43	2930	90.1	90.2	89.1	0.90	3.6	4.7	2.4	11.9	80	51.7	0.018996
T3A 132M1-2	9.2	29.4	17.0	9.79	27.9	16.1	9.30	26.9	15.5	8.96	2930	90.6	91.2	90.5	0.91	3.2	4.2	2.6	11.6	81	58.3	0.021619
T3A 132M2-2	11	34.5	19.9	11.5	32.8	18.9	10.9	31.6	18.2	10.5	2930	91.2	91.5	91.2	0.92	3.6	4.1	2.4	12.2	83	63.5	0.024142
T3A 132M3-2	15	47.7	27.6	15.9	45.3	26.2	15.1	43.7	25.2	14.6	2940	91.9	92.1	91.2	0.90	4.9	4.9	2	14.4	86	75	0.028557
T3A 160M1-2	11	36.1	20.8	12.0	34.3	19.8	11.4	33.0	19.1	11.0	2960	91.2	91	89.6	0.88	3.2	4	1.4	10.3	86	85.5	0.059613
T3A 160M2-2	15	48.3	27.9	16.1	45.8	26.5	15.3	44.2	25.5	14.7	2960	91.9	91.5	89.9	0.89	3.9	4.2	1.4	11.4	86	104	0.076751
T3A 160L1-2	18.5	57.9	33.4	19.3	55.0	31.8	18.3	53.0	30.6	17.7	2950	92.4	92.8	91.8	0.91	3	3	1.5	9.1	86	121	0.092252
T3A 180M-2	22	68.6	39.6	22.9	65.2	37.6	21.7	62.8	36.3	20.9	2960	92.7	93	92.4	0.91	2.7	3.3	1.7	9	91	130.6	0.104677
T3A 200L1-2	30	94.0	54.3	31.3	89.3	51.6	29.8	86.1	49.7	28.7	2960	93.3	93.2	92.2	0.90	3.5	3.8	1.8	10.2	94	158	0.136738
T3A 200L2-2	37	115.5	66.7	38.5	109.7	63.3	36.6	105.7	61.0	35.2	2960	93.7	93.6	92.6	0.90	3.6	3.7	1.7	9.8	94	173.1	0.163308
T3A 631-4	0.12	0.70	0.40	0.23	0.66	0.38	0.22	0.64	0.37	0.21	1360	64.8	63.7	57.6	0.70	2.2	2.3	2	3.5	52	3.8	0.000305
T3A 632-4	0.18	0.97	0.56	0.32	0.92	0.53	0.31	0.89	0.51	0.30	1400	69.9	69.6	65.4	0.70	2.2	2.5	2.1	4.1	52	4.5	0.000399
T3A 711-4	0.25	1.30	0.75	0.43	1.23	0.71	0.41	1.19	0.69	0.40	1410	73.5	73.2	69.0	0.69	2.3	2.5	2.1	4.5	55	5.8	0.000717
T3A 712-4	0.37	1.85	1.07	0.62	1.76	1.02	0.59	1.70	0.98	0.57	1420	77.3	77.1	73.6	0.68	2.8	3	2.5	5.2	55	7	0.000965
T3A 801-4	0.55	2.80	1.62	0.93	2.66	1.54	0.89	2.56	1.48	0.85	1440	80.8	79.9	76.0	0.64	3.1	3.3	2.4	6.2	57	9.5	0.001690
T3A 802-4	0.75	3.47	2.00	1.16	3.29	1.90	1.10	3.17	1.83	1.06	1440	82.5	82.5	80.1	0.69	3.1	3.1	2.5	6.3	58	11.7	0.002285
T3A 803-4	1.1	4.65	2.69	1.55	4.42	2.55	1.47	4.26	2.46	1.42	1430	84.1	84.9	83.7	0.74	3	3.1	2.6	6.6	61	13.8	0.002998
T3A 90S-4	1.1	4.72	2.72	1.57	4.48	2.59	1.49	4.32	2.49	1.44	1440	84.1	84.2	82.9	0.73	4	3.4	2.5	7.1	61	15.1	0.003842
T3A 90L1-4	1.5	6.25	3.61	2.08	5.94	3.43	1.98	5.73	3.31	1.91	1430	85.3	85.5	84.1	0.74	3.4	3.3	2.8	7.1	61	18	0.004685

# T3A Series IE3 Efficiency Motors Technical Data ( at 50Hz )

Model	Power	Current(A)			Current(A)			Current(A)			Speed (r/min)	Eff.			Power Factor	Tstart/Tn (Times)	Tmax/Tn (Times)	Tmin/Tn (Times)	Is/In (Times)	Noise dB(A)	W.T (kg)	Inertia kg*m <sup>2</sup>
		220V	380V	660V	230V	400V	690V	240V	415V	720V		100%	75%	50%								
T3A 100L1-4	2.2	8.35	4.82	2.78	7.93	4.58	2.64	7.64	4.41	2.55	1450	86.7	87.1	86.2	0.80	2.8	3.3	2.3	7.9	64	23.9	0.008754
T3A 100L2-4	3	11.5	6.66	3.85	11.0	6.33	3.65	10.6	6.10	3.52	1450	87.7	88	86.9	0.78	3.3	3.4	2.7	8.1	64	28.3	0.011063
T3A 112M1-4	4	14.5	8.37	4.83	13.8	7.95	4.59	13.3	7.66	4.42	1450	88.6	88.8	88.2	0.82	3.1	3.7	2.6	8.6	65	33.9	0.015292
T3A 112M2-4	5.5	20.2	11.7	6.73	19.2	11.1	6.39	18.5	10.7	6.16	1450	89.6	89.9	89.1	0.80	3.8	3.7	2.5	9.1	71	39.1	0.048758
T3A 132S-4	5.5	19.2	11.1	6.41	18.3	10.5	6.09	17.6	10.2	5.87	1460	89.6	89.8	89.4	0.84	2.3	3.5	1.9	9	71	47.4	0.034464
T3A 132M1-4	7.5	26.0	15.0	8.66	24.7	14.3	8.23	23.8	13.7	7.93	1460	90.4	90.9	90.3	0.84	2.6	3.4	2.2	8.9	71	57.4	0.043597
T3A 132M2-4	9.2	32.5	18.8	10.8	30.9	17.8	10.3	29.8	17.2	9.93	1460	90.8	91.3	90.7	0.82	3.2	3.6	2	10	74	60	0.051339
T3A 132M3-4	11	37.7	21.8	12.6	35.8	20.7	11.9	34.5	19.9	11.5	1460	91.4	92	91.6	0.84	3.5	3.7	2.1	10.5	75	67	0.060372
T3A 160M-4	11	38.2	22.0	12.7	36.3	20.9	12.1	34.9	20.2	11.6	1470	91.4	91.7	89.8	0.83	2.6	2.8	1.8	7.6	75	89	0.105373
T3A 160L1-4	15	50.4	29.1	16.8	47.9	27.7	16.0	46.2	26.7	15.4	1470	92.1	92.3	91.3	0.85	3	3	2	9.2	75	110.5	0.137038
T3A 180M-4	18.5	61.1	35.3	20.4	58.1	33.5	19.4	56.0	32.3	18.7	1470	92.6	92.8	92.1	0.86	2.8	3.3	1.9	8.8	80	130	0.173293
T3A 180L-4	22	72.4	41.8	24.1	68.8	39.7	22.9	66.3	38.3	22.1	1470	93	93.1	92.3	0.86	3	3.5	2.1	9.3	80	145.4	0.200637
T3A 200L-4	30	95.8	55.3	32.0	91.1	52.6	30.4	87.8	50.7	29.3	1470	93.6	93.7	92.9	0.88	3.2	3.7	2.1	9.7	83	180	0.265100
T3A 711-6	0.18	1.20	0.69	0.40	1.14	0.66	0.38	1.09	0.63	0.36	930	63.9	61	53.4	0.62	2.4	2.6	2.3	3.5	52	5.4	0.000790
T3A 712-6	0.25	1.48	0.85	0.49	1.40	0.81	0.47	1.35	0.78	0.45	920	68.6	67.2	61.2	0.65	2.2	2.5	2.2	3.7	52	6.3	0.001020
T3A 801-6	0.37	1.95	1.12	0.65	1.85	1.07	0.62	1.78	1.03	0.59	930	73.5	73.8	70.5	0.68	2.2	2.5	2.1	4.1	56	9.3	0.002189
T3A 802-6	0.55	2.64	1.52	0.88	2.51	1.45	0.84	2.42	1.40	0.81	930	77.2	78.1	75.7	0.71	2.3	2.4	2.1	4.3	56	10.9	0.002931
T3A 90S-6	0.75	3.73	2.16	1.24	3.55	2.05	1.18	3.42	1.97	1.14	950	78.9	80.1	78.1	0.67	2.3	2.6	2.1	4.7	59	13.8	0.004070
T3A 90L-6	1.1	5.33	3.08	1.78	5.07	2.93	1.69	4.88	2.82	1.63	950	81	81.1	78.4	0.67	2.7	2.9	2.5	5.2	59	16.2	0.005487
T3A 90L2-6	1.5	7.14	4.12	2.38	6.78	3.92	2.26	6.54	3.78	2.18	950	82.5	82.7	80.5	0.67	2.9	3	2.6	5.6	61	21.3	0.006895
T3A 100L-6	1.5	6.84	3.95	2.28	6.49	3.75	2.16	6.26	3.61	2.09	955	82.5	83	81.8	0.70	2.4	2.9	2.2	5.5	61	22.1	0.009137
T3A 100L2-6	2.2	9.54	5.51	3.18	9.06	5.23	3.02	8.73	5.04	2.91	955	84.3	85.1	83.9	0.72	2.5	3	2.3	6.2	64	27.7	0.012725
T3A 112M-6	2.2	10.1	5.83	3.37	9.59	5.54	3.20	9.25	5.34	3.08	965	84.3	84.5	83.2	0.68	2	2.5	1.8	5.5	64	27.1	0.017675
T3A 112M2-6	3	13.4	7.72	4.46	12.7	7.33	4.23	12.2	7.07	4.08	965	85.6	86.2	84.8	0.69	2.5	2.9	1.9	6.3	64	33.1	0.021400
T3A 132S-6	3	12.5	7.20	4.15	11.8	6.84	3.95	11.4	6.59	3.80	965	85.6	86	85.1	0.74	2	2.7	1.7	6	64	38.6	0.033804
T3A 132M1-6	4	16.4	9.46	5.46	15.6	8.99	5.19	15.0	8.66	5.00	970	86.8	87.1	86.2	0.74	2.3	3	1.8	6.8	68	47.6	0.043946
T3A 132M2-6	5.5	23.2	13.4	7.72	22.0	12.7	7.34	21.2	12.2	7.07	975	88	88.3	87.1	0.71	2.9	3.5	2.2	7.4	68	55.7	0.053987
T3A 132M3-6	7.5	30.8	17.8	10.3	29.2	16.9	9.74	28.2	16.3	9.39	970	89.1	89.6	88.6	0.72	3.3	3.2	2	8.3	68	67.6	0.070723
T3A 160M-6	7.5	29.1	16.8	9.72	27.7	16.0	9.23	26.7	15.4	8.90	975	89.1	89.5	88.5	0.76	2.2	2.9	1.8	7.3	68	79.6	0.109012
T3A 160L-6	11	41.1	23.7	13.7	39.0	22.5	13.0	37.6	21.7	12.5	975	90.3	90.8	89.9	0.78	2.7	2.9	1.2	8.4	73	105	0.154850
T3A 180L-6	15	52.1	30.1	17.4	49.5	28.6	16.5	47.7	27.6	15.9	960	91.2	90.9	89.4	0.83	2.3	2.9	2.1	7.8	79	125.2	0.275157
T3A 200L1-6	18.5	66.4	38.3	22.1	63.0	36.4	21.0	60.8	35.1	20.3	980	91.7	91.5	90.1	0.80	2.7	3.7	2.2	9.8	82	143	0.332066
T3A 200L2-6	22	78.5	45.3	26.2	74.6	43.1	24.9	71.9	41.5	24.0	980	92.2	92	90.6	0.80	2.9	3.7	2.3	10.5	82	162	0.388316

IEC MOTOR

FIRE PUMP MOTOR

GOST MOTOR

NEMA MOTOR

DC MOTOR

EC MOTOR

# MEPS2(Aus) Efficiency Motors Technical Data ( at 50Hz )

Model	Power (kW)	Current(A)			Current(A)			Speed (r/min)	Eff. (%)	Power factor (cos φ)	T <sub>st</sub> /T <sub>n</sub> (Times)	T <sub>max</sub> /T <sub>n</sub> (Times)	T <sub>min</sub> /T <sub>n</sub> (Times)	I <sub>st</sub> /I <sub>n</sub> (Times)	Inertia kg*m <sup>2</sup>
		230V	400V	690V	240V	415V	720V								
TAI 801-2	0.75	2.99	1.72	1.00	2.88	1.66	0.96	2890	80.5	0.78	2.9	3.3	1.9	7	0.000972
TAI 802-2	1.1	4.05	2.34	1.35	3.90	2.25	1.30	2890	82.8	0.82	2.8	2.8	1.8	7.6	0.001200
TAI 90S-2	1.5	5.44	3.14	1.81	5.24	3.03	1.75	2880	84.1	0.82	2.8	3	2	7.2	0.001856
TAI 90L-2	2.2	7.74	4.47	2.58	7.46	4.31	2.49	2900	85.6	0.83	3	3.1	2.2	8.2	0.002416
TAI 100L1-2	3	10.1	5.81	3.35	9.70	5.60	3.23	2910	86.7	0.86	3.1	3.5	2.6	8.8	0.004131
TAI 112M1-2	4	12.8	7.41	4.28	12.4	7.14	4.12	2920	87.6	0.89	3.3	3.6	2	9.6	0.006311
TAI 112M2-2	5.5	17.9	10.3	5.95	17.2	9.94	5.74	2920	88.5	0.87	3.4	4.1	2.8	10.2	0.008087
TAI 132S1-2	5.5	17.7	10.2	5.89	17.0	9.83	5.67	2920	88.5	0.88	2.4	3.4	1.9	8.3	0.013319
TAI 132S2-2	7.5	23.5	13.6	7.85	22.7	13.1	7.56	2920	89.5	0.89	3.1	3.7	2	10.3	0.016473
TAI 160M1-2	11	34.1	19.7	11.4	32.9	19.0	11.0	2950	90.6	0.89	2.6	3.4	1.5	8.4	0.050092
TAI 160M2-2	15	45.6	26.3	15.2	44.0	25.4	14.7	2950	91.3	0.9	2.6	3.4	1.8	9.4	0.065326
TAI 160L-2	18.5	56.0	32.3	18.7	54.0	31.2	18.0	2950	91.8	0.9	2.6	3.2	1.8	9.4	0.077018
TAI 180M-2	22	65.6	37.8	21.9	63.2	36.5	21.1	2950	92.2	0.91	2.5	2	1.4	8.1	0.095016
TAI 200L1-2	30	88.7	51.2	29.6	85.5	49.4	28.5	2950	92.9	0.91	2.5	3.3	1.3	8.8	0.122246
TAI 200L2-2	37	108.9	62.9	36.3	105.0	60.6	35.0	2960	93.3	0.91	2.8	3.5	1.3	9.6	0.148816
TAI 802-4	0.75	3.31	1.91	1.10	3.19	1.84	1.06	1420	82.2	0.69	3	3.1	2.5	5.5	0.002047
TAI 90S-4	1.1	4.38	2.53	1.46	4.22	2.43	1.41	1420	83.8	0.75	2.9	2.8	2.2	6.2	0.003508
TAI 90L1-4	1.5	5.88	3.40	1.96	5.67	3.27	1.89	1440	85	0.75	3	3.2	2.4	7.3	0.004352
TAI 90L2-4	2.2	8.49	4.90	2.83	8.18	4.72	2.73	1430	86.4	0.75	3.4	2.4	2.2	7.1	0.005352
TAI 100L1-4	2.2	7.76	4.48	2.59	7.48	4.32	2.49	1440	86.4	0.82	2.6	3.1	2.1	7.3	0.007765
TAI 100L2-4	3	10.7	6.19	3.58	10.3	5.97	3.45	1450	87.4	0.8	2.9	3.4	2.4	8.1	0.009743
TAI 112M1-4	4	14.2	8.17	4.72	13.6	7.88	4.55	1440	88.3	0.8	2.8	3.3	2.6	7.4	0.013744
TAI 112M2-4	5.5	19.3	11.1	6.42	18.6	10.7	6.19	1430	89.2	0.8	3.7	3.5	3.1	8.3	0.017355
TAI 132S-4	5.5	18.4	10.6	6.12	17.7	10.2	5.90	1460	89.2	0.84	2	2.9	1.7	7.9	0.030593
TAI 132M1-4	7.5	24.8	14.3	8.26	23.9	13.8	7.96	1460	90.1	0.84	2.8	3.2	1.8	8.7	0.039726
TAI 132M3-4	11	35.6	20.5	11.9	34.3	19.8	11.4	1460	91	0.85	3.3	3.6	1.4	9.3	0.053920
TAI 160M-4	11	36.0	20.8	12.0	34.7	20.0	11.6	1470	91	0.84	2.5	2.7	1.7	7	0.089674
TAI 160L1-4	15	48.6	28.1	16.2	46.9	27.1	15.6	1470	91.8	0.84	2.5	2.8	1.6	8.3	0.118199
TAI 180M-4	18.5	57.7	33.3	19.2	55.6	32.1	18.5	1460	92.2	0.87	2.4	3	1.8	7.8	0.155064
TAI 180L-4	22	67.5	39.0	22.5	65.1	37.6	21.7	1460	92.6	0.88	2.4	2.8	1.7	7.7	0.173293
TAI 200L-4	30	93.6	54.0	31.2	90.2	52.1	30.1	1470	93.2	0.86	3.2	3.7	2.3	9.5	0.242313
TAI 90S-6	0.75	3.71	2.14	1.24	3.58	2.07	1.19	940	77.7	0.65	2.2	2.5	1.9	4.5	0.003467
TAI 90L-6	1.1	5.06	2.92	1.69	4.88	2.82	1.63	950	79.9	0.68	2.5	2.7	2.2	5.1	0.004884
TAI 100L1-6	1.5	6.22	3.59	2.07	5.99	3.46	2.00	950	81.5	0.74	1.7	2.2	1.6	4.8	0.008340
TAI 112M-6	2.2	9.03	5.22	3.01	8.71	5.03	2.90	955	83.4	0.73	2.1	2.7	1.8	5.5	0.015440
TAI 132S-6	3	11.6	6.71	3.87	11.2	6.47	3.73	965	84.9	0.76	1.8	2.5	1.5	6.1	0.032131
TAI 132M1-6	4	15.7	9.06	5.23	15.1	8.73	5.04	965	86.1	0.74	2	2.6	1.6	5.9	0.038925
TAI 132M2-6	5.5	21.0	12.1	6.99	20.2	11.7	6.74	965	87.4	0.75	2.4	2.6	1.8	6.6	0.048966
TAI 160M-6	7.5	27.5	15.9	9.17	26.5	15.3	8.84	965	88.5	0.77	2.5	2.9	1.8	6.9	0.093821
TAI 160L-6	11	40.3	23.3	13.4	38.8	22.4	12.9	970	89.8	0.76	2.2	2.3	1.3	6.5	0.128267
TAI 180L-6	15	49.8	28.8	16.6	48.0	27.7	16.0	965	90.7	0.83	2.2	2.7	1.2	8	0.254063
TAI 200L1-6	18.5	61.0	35.2	20.3	58.8	34.0	19.6	975	91.3	0.83	2.1	2.9	1.5	8.3	0.303941
TAI 200L2-6	22	72.2	41.7	24.1	69.6	40.2	23.2	975	91.8	0.83	2.2	3	1.6	8.9	0.353160



# IEC Frame-NEMA EPACT Efficiency Motors Technical Data ( at 60Hz )

Model	Power		Current(A)		Current(A)	Speed (r/min)	Eff. (%)	Power factor (cos φ)	T <sub>st</sub> /T <sub>n</sub> (Times)	T <sub>max</sub> /T <sub>n</sub> (Times)	T <sub>min</sub> /T <sub>n</sub> (Times)	I <sub>st</sub> /I <sub>n</sub> (Times)	Inertia kg*m <sup>2</sup>
	(HP)	(kW)	230V	460V	575V								
TAF 801-2	1	0.75	3.24	1.62	1.30	3480	75.5	0.77	2.2	3.2	2.2	5.9	0.000896
TAF 802-2	1.5	1.1	4.13	2.07	1.65	3480	82.5	0.81	3.5	3.6	2.6	8.4	0.001124
TAF 90S-2	2	1.5	5.47	2.73	2.19	3510	84	0.82	3.3	3.7	1.7	9.2	0.001856
TAF 90L-2	3	2.2	7.78	3.89	3.11	3510	85.5	0.83	3.3	3.8	2.3	9.6	0.002306
TAF 100L1-2	4	3	9.78	4.89	3.91	3510	87.5	0.88	4.1	4.7	3.1	10.8	0.004842
TAF 112M1-2	5.5	4	12.8	6.38	5.10	3500	87.5	0.9	2.9	3.9	2.2	9.5	0.006311
TAF 132S1-2	7.5	5.5	17.1	8.57	6.86	3520	88.5	0.91	2.2	3.6	1.4	9	0.013950
TAF 132S2-2	10	7.5	22.9	11.4	9.15	3530	89.5	0.92	3.1	4.1	1.7	10.8	0.017735
TAF 160M1-2	15	11	34.4	17.2	13.8	3550	90.2	0.89	3	3.4	1.7	9.4	0.050092
TAF 160M2-2	20	15	46.4	23.2	18.6	3550	90.2	0.9	2.9	3.1	1.6	8.9	0.059613
TAF 160L-2	25	18.5	56.1	28.0	22.4	3550	91	0.91	3	3.3	1.8	9.6	0.069401
TAF 802-4	1	0.75	3.36	1.68	1.34	1740	82.5	0.68	3.4	3.7	2.9	7.1	0.001928
TAF 90S-4	1.5	1.1	4.63	2.31	1.85	1740	84	0.71	3.2	3.6	2.7	7.2	0.003342
TAF 90L1-4	2	1.5	5.98	2.99	2.39	1730	84	0.75	3	3.1	2.3	7.2	0.003852
TAF 100L1-4	3	2.2	7.79	3.90	3.12	1750	87.5	0.81	2.3	3.7	2.3	9.1	0.009084
TAF 100L2-4	4	3	10.37	5.18	4.15	1750	87.5	0.83	2.7	3.7	2.2	9	0.010403
TAF 112M1-4	5.5	4	13.8	6.91	5.53	1740	87.5	0.83	2.3	3.3	2.2	8.3	0.012197
TAF 132S-4	7.5	5.5	18.4	9.18	7.35	1760	89.5	0.84	2	3.5	1.9	9.1	0.030593
TAF 132M1-4	10	7.5	24.5	12.2	9.78	1760	89.5	0.86	2.7	3.4	1.6	9.3	0.037145
TAF 160M-4	15	11	36.1	18.1	14.4	1760	91	0.84	2.6	2.8	1.6	7.8	0.089674
TAF 160L1-4	20	15	48.7	24.3	19.5	1760	91	0.85	2.7	2.7	1.6	7.8	0.105640
TAF 90S-6	1	0.75	3.51	1.76	1.41	1145	80	0.67	2.2	2.6	2.1	5	0.003668
TAF 100L0-6	1.5	1.1	5.47	2.74	2.19	1170	85.5	0.59	3.3	4	2.6	7	0.009137
TAF 100L1-6	2	1.5	6.50	3.25	2.60	1160	86.5	0.67	3.3	3.8	3	6.9	0.011529
TAF 112M-6	3	2.2	9.02	4.51	3.61	1170	87.5	0.7	2.6	3.2	2	6.9	0.019910
TAF 132S-6	4	3	12.0	5.98	4.78	1170	87.5	0.72	2	2.8	1.7	6.3	0.035478
TAF 132M1-6	5.5	4	15.7	7.86	6.29	1170	87.5	0.73	2.2	2.8	1.7	6.6	0.038925
TAF 132M2-6	7.5	5.5	20.8	10.4	8.34	1170	89.5	0.74	2.4	3	1.9	7.3	0.059008
TAF 160M-6	10	7.5	27.0	13.5	10.8	1160	89.5	0.78	2.2	2.8	1.8	7	0.101417
TAF 160L-6	15	11	39.2	19.6	15.7	1170	90.2	0.78	2.3	2.9	1.8	7.2	0.128267

IEC MOTOR

FIRE PUMP MOTOR

GOST MOTOR

NEMA MOTOR

DC MOTOR

EC MOTOR

# IEC Frame-NEMA Premium Efficiency Motors Technical Data ( at 60Hz )

Model	Power		Current(A)		Current(A)	Speed (r/min)	Eff. (%)	Power factor (cos φ)	T <sub>st</sub> /T <sub>n</sub> (Times)	T <sub>max</sub> /T <sub>n</sub> (Times)	T <sub>min</sub> /T <sub>n</sub> (Times)	I <sub>s</sub> /I <sub>n</sub> (Times)	Inertia kg*m <sup>2</sup>
	(HP)	(kW)	230V	460V	575V								
T 801-2	1	0.75	3.13	1.57	1.25	3490	77	0.78	2.7	3.1	1.5	7.3	0.000896
T 802-2	1.5	1.1	4.11	2.05	1.64	3510	84	0.8	3.8	4.1	2.6	9.7	0.001275
T 90S-2	2	1.5	5.18	2.59	2.07	3500	85.5	0.85	2.9	3.3	2	9.1	0.001966
T 90L-2	3	2.2	7.34	3.67	2.94	3490	86.5	0.87	2.7	3.3	1.6	8.4	0.002416
T 100L1-2	4	3	9.56	4.78	3.82	3520	88.5	0.89	4.9	4.7	2.4	11.9	0.005197
T 112M1-2	5.5	4	12.6	6.30	5.04	3520	88.5	0.9	3.2	4	2.4	10.9	0.006893
T 132S1-2	7.5	5.5	17.0	8.48	6.78	3520	89.5	0.91	2.6	3.6	1.7	9.6	0.015212
T 132S2-2	10	7.5	22.7	11.3	9.08	3520	90.2	0.92	2.5	3.5	1.4	8.7	0.018996
T 132M-2	15	11	33.0	16.5	13.2	3530	91	0.92	3.5	4.7	0.8	11.5	0.023511
T 160M1-2	15	11	33.7	16.9	13.5	3550	91	0.9	2.7	3.3	0.9	8.8	0.053901
T 160M2-2	20	15	45.5	22.7	18.2	3550	91	0.91	3	3.3	1.4	9.6	0.065326
T 160L-2	25	18.5	55.7	27.8	22.3	3550	91.7	0.91	3.3	3.4	1.5	10.2	0.077018
T 802-4	1	0.75	3.06	1.53	1.22	1740	85.5	0.72	2.7	3	2.3	6.7	0.002285
T 90S-4	1.5	1.1	4.37	2.19	1.75	1740	86.5	0.73	3.6	3.7	2.6	7.7	0.003842
T 90L-4	2	1.5	5.65	2.83	2.26	1740	86.5	0.77	3	3.2	2.1	7.8	0.004685
T 100L1-4	3	2.2	7.71	3.86	3.09	1760	89.5	0.8	3	4	2.4	9.5	0.009743
T 100L2-4	4	3	10.65	5.33	4.26	1750	89.5	0.79	3.4	4.1	2.9	9.3	0.011063
T 112M1-4	5.4	4	13.2	6.60	5.28	1750	89.5	0.85	2.8	3.5	2.2	8.9	0.015292
T 132S-4	7.5	5.5	17.9	8.96	7.17	1770	91.7	0.84	2.6	4	1.9	10.1	0.038335
T 132M1-4	10	7.5	23.9	11.9	9.55	1760	91.7	0.86	3.1	3.8	1.7	10.3	0.046178
T 160M-4	15	11	36.0	18.0	14.4	1770	92.4	0.83	3.1	3.1	2	9	0.105373
T 160L1-4	20	15	47.6	23.8	19.1	1770	93	0.85	3.2	3	2	8.9	0.137038
T 90S-6	1	0.75	3.26	1.63	1.30	1145	82.5	0.7	2.3	2.7	2.1	5.2	0.004472
T 100L0-6	1.5	1.1	4.93	2.47	1.97	1175	87.5	0.64	3	3.6	2.4	7.1	0.011529
T 100L1-6	2	1.5	6.65	3.32	2.66	1170	88.5	0.64	2.9	3.9	2.8	7.2	0.013124
T 112M-6	3	2.2	8.94	4.47	3.58	1175	89.5	0.69	3.2	3.7	2.2	7.9	0.025870
T 132S-6	4	3	12.0	6.01	4.81	1175	89.5	0.7	2.6	3.2	1.9	7.1	0.048867
T 132M1-6	5.5	4	14.8	7.38	5.90	1170	89.5	0.76	2.3	2.9	1.6	7.3	0.053987
T 132M2-6	7.5	5.5	20.2	10.1	8.09	1170	91	0.75	3.4	3.5	1.9	8.8	0.079091
T 160M-6	10	7.5	27.6	13.8	11.0	1180	91	0.75	3.1	3.7	1.7	8.4	0.128267
T 160L-6	15	11	40.7	20.3	16.3	1180	91.7	0.74	3.1	3.7	1.7	8.5	0.177635

# “ECOL” Motors in Cast Iron Housing

## FEATURES

- Energy savings, high efficiency
- High starting torque, lower starting current
- Versatile and easy to modify design adapts to a variety of applications
- Option of integrated or removable feet
- Option of terminal box location (top, left or right)
- Option of IE2, IE3, MEPS High and Premium Efficiency for IEC standards + NEMA EPACT and Premium Efficiency
- Contained total length is the same as or shorter than the current market standard
- Full use of the magnetization properties of cold rolled silicone steel in which the stator laminations are magnetized evenly to reduce temperature rise of the winding

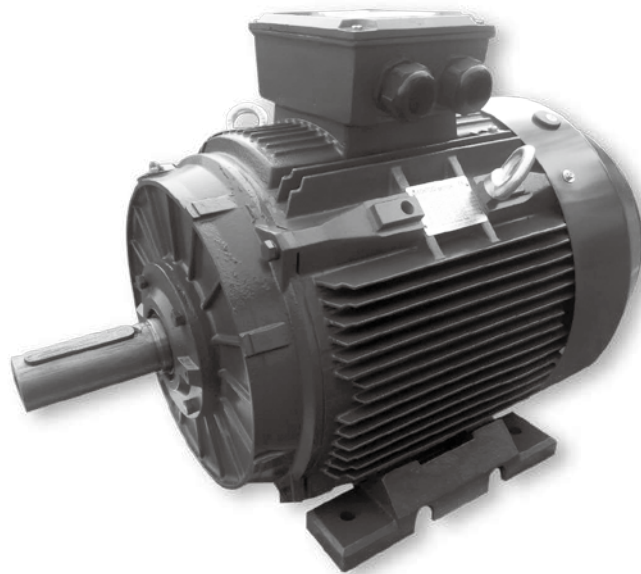

## APPLICATIONS

- Pumps
- Waste water treatment plants
- Air compressors, fans
- Gear reducers and power transmission
- Pulp and paper mills
- Steel mill
- Conveyors, elevators
- Should be "Material handling equipment"
- Agricultural application
- Mining equipment
- Hydraulic equipment

# Motor Spare Part List "Exploded Drawing"

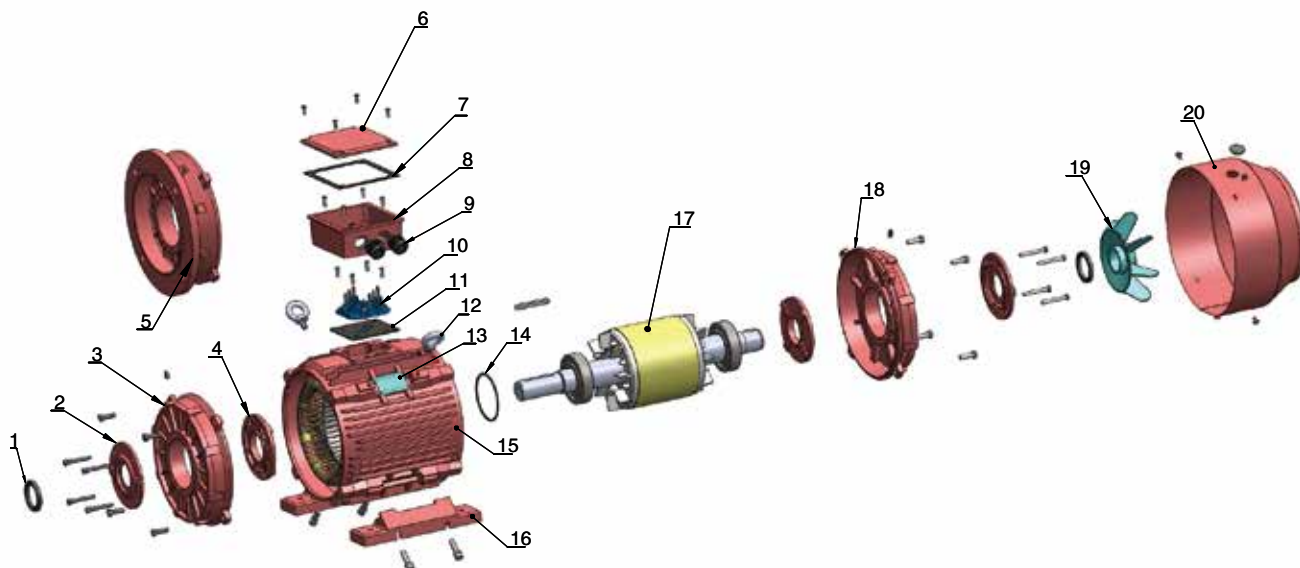

- |                          |                    |                      |                   |
|--------------------------|--------------------|----------------------|-------------------|
| 1. Oil seal              | 6. TB cover        | 11. TB bottom gasket | 16. Foot          |
| 2. Outer bearing cap D.E | 7. TB upper gasket | 12. Eye bolt         | 17. Rotor         |
| 3. DE endshield          | 8. TB base         | 13. Nameplate        | 18. NDE endshield |
| 4. Inner bearing cap D.E | 9. Cable gland     | 14. Wave washer      | 19. Cooling fan   |
| 5. B5 flange             | 10. Terminal board | 15. Frame            | 20. Fan cover     |

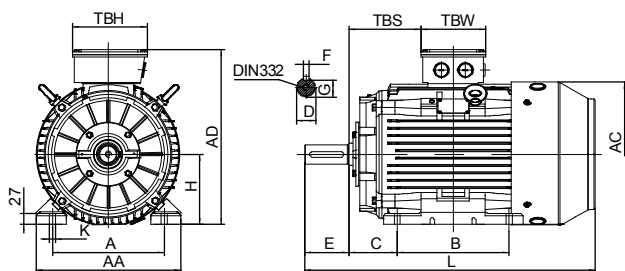

IM B3

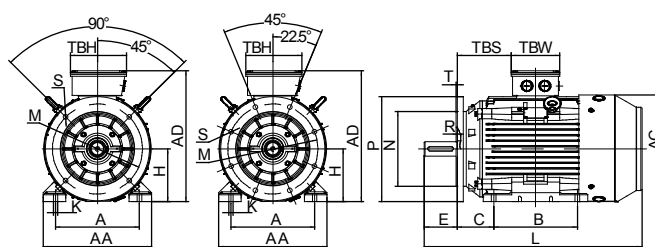

IM B35

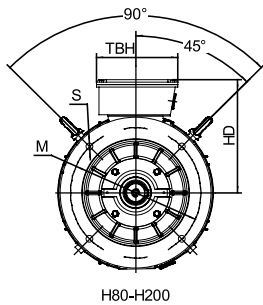

H80-H200

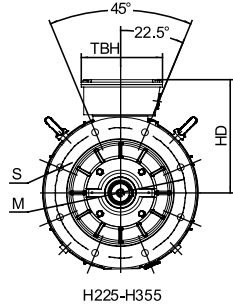

H225-H355

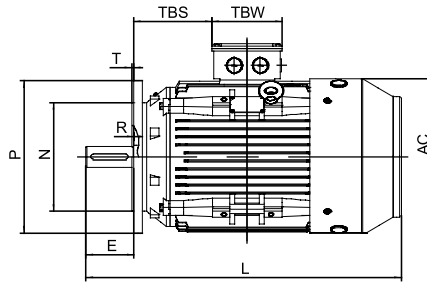

IM B5

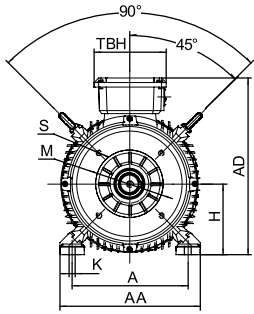

IM B34

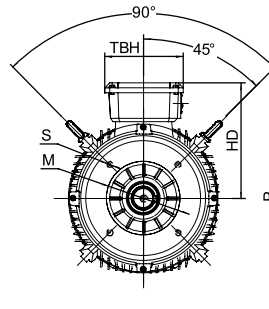
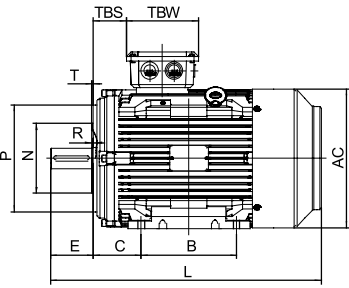

IM B14

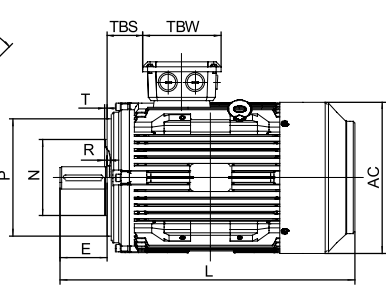

## Overall & Installation Dimensions

Frame	Foot Mounting				Shaft					General								
	H	A	B	C	D	E	F	G	K	AA	AD	HD	AC	L	TBS	TBW	TBH	
80	80	125	100	50	φ 19	40	6	15.5	φ 9	154	214	134	φ 158	290	43	114	114	
90S/L	90	140	100/125	56	φ 24	50	8	20	φ 10	178	231	141	φ 176	320/345	49/61.5	114	114	
100L	100	160	140	63	φ 28	60	8	24	φ 12	203	251	151	φ 199	385	76	114	114	
112M	112	190	140	70	φ 28	60	8	24	φ 12	231	292	180	φ 220	405	73	134	134	
132S/M	132	216	140/178	89	φ 38	80	10	33	φ 12	263	332	200	φ 259	467/505	61.5	134	134	
160M/L	160	254	210/254	108	φ 42	110	12	37	φ 15	316	404	244	φ 313	605/650	91	162	187	
180M/L	180	279	241/279	121	φ 48	110	14	42.5	φ 15	354	445	265	φ 360	687/725	160/180	162	187	
200L	200	318	305	133	φ 55	110	16	49	φ 19	393	500	300	φ 399	768.5	192	186	233	
225S	4,6,8	225	356	286	149	φ 60	140	18	53	φ 19	440	558	333	φ 459	810	199	186	233
	2	225	356	311	149	φ 55	110	16	49	φ 19	440	558	333	φ 459	805	211.5	186	233
225M	4,6,8	225	356	311	149	φ 60	140	18	53	φ 19	440	558	333	φ 459	835	211.5	186	233
	2	250	406	349	168	φ 60	140	18	53	φ 24	484	616	366	φ 506	915	233	218	260
250M	4,6,8	250	406	349	168	φ 65	140	18	58	φ 24	484	616	366	φ 506	915	233	218	260
	2	280	457	368/419	190	φ 65	140	18	58	φ 24	560	675	395	φ 559	984/1035	265/277	218/245	260/280
280S/M	4,6,8	280	457	368/419	190	φ 75	140	20	67.5	φ 24	560	675	395	φ 559	984/1035	265/277	218/245	260/280
	2	315	508	406	216	φ 65	140	18	58	φ 28	628	825	510	φ 680	1205	200	290	350
315S	4,6,8	315	508	406	216	φ 80	170	22	71	φ 28	628	825	510	φ 680	1235	200	290	350
	2	315	508	457/508	216	φ 65	140	18	58	φ 28	628	825	510	φ 680	1355	200	290	350
315M/L	4,6,8	315	508	457/508	216	φ 80	170	22	71	φ 28	628	825	510	φ 680	1385	200	290	350
	2	355	610	560/630	254	φ 75	140	20	67.5	φ 28	740	1010	655	φ 820	1495	140	330	380
355M/L	4,6,8	355	610	560/630	254	φ 95	170	25	86	φ 28	740	1010	655	φ 820	1525	140	330	380
	4,6,8	355	610	560/630	254	φ 100	210	28	90	φ 28	740	1010	655	φ 820	1565	140	330	380

Frame	Bearings		Cable Gland	B5						B14					
	DE	NDE		N	M	P	S	T	R	N	M	P	S	T	R
80	6204		1-M20×1.5	φ 130	φ 165	φ 200	4×φ 12	3.5	0	φ 80	φ 100	φ 120	M6	3	0
90S/L	6205		1-M20×1.5	φ 130	φ 165	φ 200	4×φ 12	3.5	0	95	115	140	M8	3	0
100L	6206		1-M20×1.5	φ 180	φ 215	φ 250	4×φ 15	4	0	110	130	160	M8	3.5	0
112M	6306		2-M25×1.5	φ 180	φ 215	φ 250	4×φ 15	4	0	110	130	160	M8	3.5	0
132S/M	6308		2-M25×1.5	φ 230	φ 265	φ 300	4×φ 15	4	0	130	165	200	M10	3.5	0
160M/L	6309		2-M32×1.5	φ 250	φ 300	φ 350	4×φ 19	5	0	180	215	250	M12	5	0
180M/L	6311		2-M32×1.5	φ 250	φ 300	φ 350	4×φ 19	5	0						
200L	6312		2-M40×1.5	φ 300	φ 350	φ 400	4×φ 19	5	0						
225S/M	6313		2-M50×1.5	φ 350	φ 400	φ 450	8×φ 19	5	0						
250M	6314		2-M50×1.5	φ 450	φ 500	φ 550	8×φ 19	5	0						
280S/M	6316		2-M50×1.5	φ 450	φ 500	φ 550	8×φ 19	5	0						
315S/M/L	2	6317		2-M63×1.5	φ 550	φ 600	φ 660	8×φ 24	6	0					
	4,6,8	NU319	6319												
355M/L	2	6319		2-M63×1.5	φ 680	φ 740	φ 800	8×φ 24	6	0					
	4,6,8	NU322	6322												

IEC MOTOR  
FIRE PUMP MOTOR  
GOST MOTOR  
NEMA MOTOR  
DC MOTOR  
EC MOTOR

# T1C Series IE1 Efficiency Motors Technical Data (400V/50Hz)

Model	Output (kW)	Rated current (A)	Rotation speed (r/min)	Efficiency 100% load (%)	Efficiency 75% load (%)	Efficiency 50% load (%)	Power factor (Φ)	Rated torque (N.m)	T <sub>es</sub> /T <sub>n</sub> (Times)	T <sub>min</sub> /T <sub>n</sub> (Times)	T <sub>max</sub> /T <sub>n</sub> (Times)	I <sub>st</sub> /I <sub>n</sub> (Times)	Nosie (dB)	Net weight (kg)	Moment of inertia(kg·m <sup>2</sup> )
T1C 801-2	0.75	2.06	2840	72.1	73.3	69.0	0.73	2.52	2.2	1.8	2.3	6	67	14.3	0.00093
T1C 802-2	1.1	2.90	2840	75	77.7	74.8	0.73	3.70	2.2	1.8	2.3	7	67	16.0	0.00110
T1C 90S-2	1.5	3.79	2840	77.2	78.5	75.1	0.74	5.04	2.2	1.8	2.3	7	72	18.5	0.00184
T1C 90L-2	2.2	5.04	2840	79.7	80.9	78.8	0.79	7.40	2.2	1.8	2.3	7.5	72	22.0	0.00239
T1C 100L-2	3	6.56	2840	81.5	82.8	80.1	0.81	10.09	2.2	1.8	2.3	7.5	76	32.0	0.00368
T1C 112M-2	4	8.58	2900	83.1	84.9	82.6	0.81	13.17	2.2	1.8	2.3	7.5	77	41.0	0.01613
T1C 132S1-2	5.5	11.16	2900	84.7	85.5	82.8	0.84	18.11	2.2	1.8	2.3	7.5	80	57.5	0.01106
T1C 132S2-2	7.5	14.81	2900	86	87.1	84.7	0.85	24.70	2.2	1.8	2.3	7.5	80	62.0	0.01468
T1C 132M1-2	9.2	17.75	2900	87	88.2	86.1	0.86	30.30	2.2	1.4	2.3	7.5	80	68.5	0.01767
T1C 160M1-2	11	20.14	2945	87.6	88.9	86.6	0.90	35.67	2.2	1.4	2.3	8.5	86	111.0	0.04150
T1C 160M2-2	15	27.74	2945	88.7	90.0	88.1	0.88	48.64	2.2	1.4	2.3	9	86	122.0	0.05384
T1C 160L-2	18.5	35.18	2945	89.3	91.0	89.5	0.85	59.99	2.2	1.4	2.3	10	86	140.0	0.06436
T1C 180M-2	22	39.25	2945	89.9	89.9	87.6	0.90	71.34	2.2	1.3	2.3	8	89	153.0	0.08110
T1C 200L1-2	30	53.0	2950	90.7	91.4	89.7	0.90	97.12	2.0	1.3	2.3	7.5	92	218.0	0.15138
T1C 200L2-2	37	65.1	2950	91.2	92.7	91.5	0.90	119.8	2.0	1.3	2.3	7.5	92	230.0	0.17351
T1C 225M-2	45	78.7	2955	91.7	91.4	89.7	0.90	145.4	2.0	1.3	2.3	7.5	92	303.0	0.24178
T1C 250M-2	55	95.8	2970	92.1	92.5	90.7	0.90	176.9	2.0	1.3	2.3	9	93	391.0	0.38903
T1C 280S-2	75	129.7	2970	92.7	92.9	91.1	0.90	241.2	2.0	1.3	2.3	9	94	530.0	0.69871
T1C 280M-2	90	155.2	2970	93	92.8	90.9	0.90	289.4	2.0	1.3	2.3	9	94	572.0	0.79539
T1C 315S-2	110	189.1	2970	93.3	94.0	92.5	0.90	353.7	2.0	1.5	2.2	7	96	900.0	1.41216
T1C 315M-2	132	223.9	2970	93.5	94.1	92.8	0.91	424.4	2.0	1.5	2.2	7	96	970.0	1.55013
T1C 315L1-2	160	273.6	2970	93.8	94.2	93.0	0.90	514.5	2.0	1.5	2.2	7	99	1010.0	1.71199
T1C 315L2-2	200	341.2	2970	94	94.3	93.1	0.90	643.1	2.0	1.5	2.2	7	99	1070.0	1.90623
T1C 355M1-2	220	375.3	2980	94	94.3	93.1	0.90	705.0	2.0	1.2	2.2	7	103	1590.0	2.95585
T1C 355M2-2	250	426.5	2980	94	94.4	93.2	0.90	801.2	2.0	1.2	2.2	7	103	1650.0	3.14272
T1C 355L1-2	280	477.7	2980	94	94.5	93.2	0.90	897.3	2.0	1.2	2.2	7	103	1715.0	3.47911
T1C 355L2-2	315	537.4	2980	94	94.5	93.2	0.90	1009.5	2.0	1.2	2.2	7	103	1780.0	3.85287
T1C 801-4	0.55	1.51	1420	70	72.5	70.2	0.75	3.70	2.3	2.0	2.6	6	58	13.5	0.00141
T1C 802-4	0.75	2.00	1420	72.1	79.2	76.8	0.75	5.04	2.3	2.0	2.6	6	58	14.6	0.00168
T1C 90S-4	1.1	2.82	1430	75	77.8	74.5	0.75	7.35	2.3	2.0	2.6	6.5	61	18.0	0.00238
T1C 90L-4	1.5	3.69	1430	77.2	80.0	77.3	0.76	10.02	2.3	2.0	2.6	6.5	61	23.0	0.00335
T1C 100L1-4	2.2	4.98	1430	79.7	79.3	75.6	0.80	14.69	2.2	2.0	2.6	6.5	64	32.0	0.00688
T1C 100L2-4	3	6.64	1435	81.5	82.6	79.9	0.80	19.97	2.2	2.0	2.6	7.5	64	35.0	0.00883
T1C 112M-4	4	8.47	1435	83.1	86.2	84.7	0.82	26.62	2.2	2.0	2.6	7.5	65	44.0	0.01311
T1C 132S-4	5.5	11.29	1440	84.7	87.5	85.6	0.83	36.48	2.2	1.6	2.6	7.5	71	61.0	0.02679
T1C 132M-4	7.5	14.81	1440	86	88.6	86.9	0.85	49.74	2.2	1.6	2.6	7.5	71	76.0	0.03694
T1C 132M2-4	9.2	18.17	1440	86	88.6	85.8	0.85	61.01	2.2	1.6	2.6	7.5	71	79.0	0.04412
T1C 160M-4	11	21.58	1465	87.6	89.7	88.8	0.84	71.71	2.2	1.6	2.6	8.5	75	115.0	0.07659
T1C 160L-4	15	28.06	1465	88.7	90.2	88.7	0.87	97.78	2.2	1.6	2.6	8	75	137.0	0.10379
T1C 180M-4	18.5	33.98	1465	89.3	90.6	89.3	0.88	120.6	2.2	1.6	2.6	8	76	149.5	0.14084
T1C 180L-4	22	40.14	1465	89.9	90.7	89.3	0.88	143.4	2.2	1.6	2.6	8	76	165.0	0.16541
T1C 200L-4	30	56.16	1475	90.7	92.3	91.6	0.85	194.2	2.2	1.6	2.6	8	79	216.5	0.26594
T1C 225S-4	37	68.9	1480	91.2	90.9	88.8	0.85	238.8	2.2	1.3	2.6	7	81	293.0	0.50439
T1C 225M-4	45	83.3	1480	91.7	92.6	91.0	0.85	290.4	2.2	1.3	2.6	7	81	335.0	0.57909
T1C 250M-4	55	100.2	1480	92.1	92.4	90.7	0.86	354.9	2.2	1.3	2.6	8	83	397.0	0.69098
T1C 280S-4	75	131.2	1480	92.7	93.1	93.2	0.89	484.0	2.2	1.3	2.6	9	86	540.0	1.41285
T1C 280M-4	90	155.2	1480	93	93.4	93.5	0.90	580.7	2.2	1.3	2.6	9	86	620.0	1.74607
T1C 315S-4	110	189.1	1480	93.3	93.8	93.2	0.90	709.8	2.0	1.3	2.3	7	93	915.0	2.90486
T1C 315M-4	132	226.4	1480	93.5	94.0	93.6	0.90	851.8	2.0	1.3	2.3	7	93	1005.0	3.29579
T1C 315L1-4	160	273.6	1480	93.8	94.0	93.5	0.90	1032.4	2.0	1.3	2.3	7	97	1068.0	3.73367
T1C 315L2-4	200	341.2	1480	94	94.3	93.9	0.90	1290.5	2.0	1.3	2.3	7	97	1210.0	4.67201
T1C 355M1-4	220	379.6	1480	94	94.5	94.0	0.89	1419.6	2.0	1.2	2.3	7	101	1560.0	6.87200
T1C 355M2-4	250	431.3	1480	94	94.5	94.0	0.89	1613.2	2.0	1.2	2.3	7	101	1600.0	7.63820
T1C 355L1-4	280	483.1	1480	94	94.5	94.0	0.89	1806.8	2.0	1.2	2.3	7	101	1650.0	8.31927
T1C 355L2-4	315	537.4	1485	94	94.6	94.1	0.90	2025.8	2.0	1.2	2.3	7	101	1700.0	9.08547
T1C 355L3-4	355	605.7	1485	94	94.6	94.1	0.90	2283.0	2.0	1.2	2.3	7	101	1780.0	10.10708

# T1C Series IE1 Efficiency Motors Technical Data (400V/50Hz)

Model	Output (kW)	Rated current (A)	Rotation speed (r/min)	Efficiency 100% load (%)	Efficiency 75% load (%)	Efficiency 50% load (%)	Power factor (Φ)	Rated torque (N.m)	T <sub>s</sub> /T <sub>n</sub> (Times)	T <sub>min</sub> /T <sub>n</sub> (Times)	T <sub>max</sub> /T <sub>n</sub> (Times)	I <sub>s</sub> /I <sub>n</sub> (Times)	Nosie (dB)	Net weight (kg)	Moment of inertia(kg·m <sup>2</sup> )
T1C 801-6	0.37	1.49	900	59.7	60.5	55.7	0.60	3.93	2.0	1.8	2.2	5.5	54	14.0	0.00231
T1C 802-6	0.55	1.95	900	65.8	66.1	62.3	0.62	5.84	2.0	1.8	2.2	5.5	54	15.0	0.00284
T1C 90S-6	0.75	2.34	935	70	70.4	65.8	0.66	7.66	2.0	1.8	2.2	5.5	57	19.0	0.00335
T1C 90L-6	1.1	3.20	935	72.9	74.2	70.8	0.68	11.24	2.0	1.8	2.2	5.5	57	21.6	0.00461
T1C 100L-6	1.5	3.94	940	75.2	75.7	72.4	0.73	15.24	2.0	1.8	2.2	5.5	61	29.5	0.00783
T1C 112M-6	2.2	5.68	940	77.7	79.3	76.2	0.72	22.35	2.0	1.8	2.2	6	65	38.0	0.01383
T1C 132S-6	3	7.24	940	79.7	80.2	76.8	0.75	30.48	2.0	1.8	2.2	6	69	49.6	0.02855
T1C 132M1-6	4	9.58	950	81.4	82.8	80.1	0.74	40.21	2.0	1.8	2.5	6	69	59.4	0.03601
T1C 132M2-6	5.5	12.91	950	83.1	83.0	80.6	0.74	55.29	2.0	1.8	2.5	7.5	69	65.0	0.04890
T1C 160M-6	7.5	16.82	965	84.7	87.0	85.2	0.76	74.22	2.0	1.3	2.5	7.5	73	112.0	0.08726
T1C 160L-6	11	24.18	970	86.4	86.7	84.4	0.76	108.3	2.0	1.3	2.5	7.5	73	122.4	0.10963
T1C 180L-6	15	29.74	970	87.7	89.1	87.8	0.83	147.7	1.8	1.2	2.2	8	73	161.5	0.24936
T1C 200L1-6	18.5	34.25	970	88.6	90.9	90.3	0.88	182.1	1.8	1.2	2.2	8	76	208.3	0.36147
T1C 200L2-6	22	40.45	970	89.2	91.0	90.5	0.88	216.6	1.8	1.2	2.2	8	76	218.2	0.39445
T1C 225M-6	30	55.2	975	90.2	91.2	89.9	0.87	293.8	1.8	1.2	2.2	7	76	289.0	0.55616
T1C 250M-6	37	70.0	980	90.8	90.7	88.6	0.84	360.6	2.0	1.3	2.2	7.5	78	380.0	0.96477
T1C 280S-6	45	83.6	980	91.4	92.6	91.6	0.85	438.5	2.0	1.3	2.2	7.5	80	489.5	1.68116
T1C 280M1-6	55	100.4	980	91.9	93.3	92.5	0.86	536.0	2.0	1.3	2.2	7.5	80	560.0	1.99928
T1C 315S-6	75	135.9	985	92.6	93.4	92.2	0.86	727.2	2.0	1.3	2.3	7	85	806.0	3.25976
T1C 315M-6	90	162.6	985	92.9	93.5	92.5	0.86	872.6	2.0	1.3	2.3	7	85	912.0	3.90933
T1C 315L1-6	110	197.9	985	93.3	93.5	92.3	0.86	1066.5	2.0	1.3	2.3	7	85	965.0	4.54331
T1C 315L2-6	132	236.9	985	93.5	93.6	92.5	0.86	1279.8	2.0	1.3	2.3	7	85	1070.0	5.44899
T1C 355M1-6	160	276.6	990	93.8	93.5	92.7	0.89	1543.4	2.0	1.2	2.2	8	92	1537.0	8.97637
T1C 355M2-6	200	341.2	990	94	93.5	92.8	0.90	1929.3	2.0	1.2	2.2	8	92	1720.0	11.00175
T1C 355L-6	250	426.5	990	94	93.6	92.8	0.90	2411.6	2.0	1.2	2.2	8	92	1880.0	13.56011
T1C 801-8	0.18	0.8	680	51	52.5	48.5	0.61	3.5	1.5	1.3	1.7	2.8	52	15	0.00214
T1C 802-8	0.25	1.1	680	56	58.2	52.5	0.61	3.5	1.6	1.3	2	2.7	52	16.1	0.00249
T1C 90S-8	0.37	1.3	680	63	63.8	58.5	0.63	5.2	1.6	1.3	1.8	2.8	56	19.2	0.00335
T1C 90L-8	0.55	1.9	680	66	67.2	62.3	0.65	7.7	1.6	1.3	1.8	3	56	21.8	0.00461
T1C 100L1-8	0.75	2.4	710	66	67.5	62.5	0.67	10.1	1.7	1.3	2.1	3.5	59	27.9	0.00688
T1C 100L2-8	1.1	3.2	710	72	72.8	67.7	0.69	14.8	1.7	1.3	2.1	3.5	59	32	0.00925
T1C 112M-8	1.5	4.3	710	74	73.2	68.6	0.68	20.2	1.8	1.2	2.1	4.2	61	39.1	0.01552
T1C 132S-8	2.2	6.0	720	75	75.5	71.1	0.71	29.2	2	1.2	2	5.5	64	58	0.03408
T1C 132M-8	3	7.7	720	77	77.2	72.6	0.73	39.8	2	1.2	2	5.5	64	64	0.04522
T1C 160M1-8	4	11.1	730	80	79.5	75.6	0.65	52.33	1.6	1.2	2.2	6	68	108	0.07620
T1C 160M2-8	5.5	14.63	730	83.5	81.6	77.7	0.65	71.95	1.6	1.2	2.2	6	68	124	0.09095
T1C 160L-8	7.5	19.6	730	85	82.8	79.5	0.65	98.12	1.6	1.2	2.2	6	68	136	0.10594
T1C 180L-8	11	24.1	730	88	87.3	84.9	0.75	143.9	2	1.4	2	6	70	174	0.25695
T1C 200L-8	15	29.7	730	89	89.3	88	0.82	196.2	1.6	1.3	2.2	7	73	220	0.36147
T1C 225S-8	18.5	37.1	735	90	88.8	87.2	0.80	240.4	1.6	1.3	2	6	73	285	0.49078
T1C 225M-8	22	43.9	735	90.5	90.4	89.1	0.80	285.9	1.6	1.3	2	6	73	310	0.58885
T1C 250M-8	30	59.5	735	91	91.9	90.8	0.80	389.8	1.6	1.0	1.8	6	75	395	1.02008
T1C 280S-8	37	74.8	740	91.5	91.2	90.5	0.78	477.5	1.9	1.2	2	6.5	76	523	1.88979
T1C 280M-8	45	90.5	740	92	92.3	90.8	0.78	580.7	1.9	1.2	2	6.5	76	575	2.26008
T1C 315S-8	55	106.9	740	92.8	92.5	91.2	0.80	709.8	2	1.3	2	6.5	82	842	3.89374
T1C 315M-8	75	145.5	740	93	92.6	91.1	0.80	967.9	2	1.3	2	6.5	82	998.8	5.26785
T1C 315L1-8	90	173.1	740	93.8	93.9	92.3	0.80	1161.5	2	1.3	2	6.5	82	1096.8	6.26411
T1C 315L2-8	110	211.1	740	94	93.2	92.2	0.80	1419.6	2	1.3	2	6.5	82	1191.2	7.44150
T1C 355M1-8	132	254.2	740	93.7	93.6	92.5	0.80	1703.5	1.8	1.3	2	6.5	90	1496.8	8.86978
T1C 355M2-8	160	306.4	740	94.2	93.6	92.3	0.80	2064.9	1.8	1.3	2	6.5	90	1592	10.04236
T1C 355L-8	200	381.8	740	94.5	93.1	92.5	0.80	2581.1	1.8	1.3	2	6.5	90	1752	12.28093

IEC MOTOR

FIRE PUMP MOTOR

GOST MOTOR

NEMA MOTOR

DC MOTOR

EC MOTOR

# T2C Series IE2 Efficiency Motors Technical Data (400V/50Hz)

Model	Output (kW)	Rated current (A)	Rotation speed (r/min)	Efficiency 100% load (%)	Efficiency 75% load (%)	Efficiency 50% load (%)	Power factor (Φ)	Rated torque (N.m)	T <sub>st</sub> /T <sub>n</sub> (Times)	T <sub>min</sub> /T <sub>n</sub> (Times)	T <sub>max</sub> /T <sub>n</sub> (Times)	I <sub>st</sub> /I <sub>n</sub> (Times)	Noise (dB)	Net weight (kg)	Moment of inertia(kg*m <sup>2</sup> )
T2C 801-2	0.75	1.73	2840	77.4	77.5	73.8	0.81	2.52	2.5	2.1	2.6	6	67	14.5	0.00084
T2C 802-2	1.1	2.43	2880	79.6	80.5	78.6	0.82	3.65	2.5	1.8	2.6	7.5	67	16.5	0.00119
T2C 90S-2	1.5	3.25	2880	81.3	81.9	81.0	0.82	4.97	2.5	1.8	2.6	7	72	18.5	0.00184
T2C 90L-2	2.2	4.60	2880	83.2	83.6	82.5	0.83	7.30	2.5	1.4	2.6	7.5	72	22.0	0.00239
T2C 100L-2	3	6.17	2890	84.6	85.5	84.0	0.83	9.91	2.5	2.0	2.8	7.5	76	33.0	0.00410
T2C 112M-2	4	7.65	2910	85.8	85.3	82.7	0.88	13.13	2.5	1.8	2.8	9.5	77	41.0	0.00607
T2C 132S1-2	5.5	10.37	2910	87	88.1	86.0	0.88	18.05	2.4	1.8	2.8	8.5	80	59.5	0.01251
T2C 132S2-2	7.5	13.96	2920	88.1	89.0	87.3	0.88	24.53	2.5	1.8	2.8	10	80	64.0	0.01613
T2C 132M1-2	9.2	17.13	2920	88.1	88.9	87.0	0.88	30.09	2.5	1.4	3.0	10	80	71.0	0.01758
T2C 160M1-2	11	19.73	2930	89.4	89.5	89.0	0.90	35.85	2.5	1.4	2.8	8.5	86	113.0	0.04561
T2C 160M2-2	15	26.64	2940	90.3	90.0	88.8	0.90	48.72	2.5	1.3	2.8	9	86	124.0	0.06206
T2C 160L-2	18.5	32.64	2940	90.9	91.3	90.0	0.90	60.09	2.5	1.4	2.8	9.5	86	140.0	0.07528
T2C 180M-2	22	38.6	2945	91.3	91.2	89.8	0.90	71.34	2.5	1.4	2.8	9	89	168.0	0.08110
T2C 200L1-2	30	52.3	2945	92	92.1	90.9	0.90	97.3	2.0	1.3	2.5	7	92	235.0	0.14253
T2C 200L2-2	37	64.2	2945	92.5	91.5	92.3	0.90	120.0	2.5	1.5	2.5	7.5	92	246.0	0.16466
T2C 225M-2	45	77.7	2950	92.9	92.4	91.6	0.90	145.7	2.5	1.3	2.4	7.5	92	321.0	0.24906
T2C 250M-2	55	94.6	2960	93.2	93.5	92.0	0.90	177.4	2.3	1.4	2.6	8.5	93	419.0	0.43328
T2C 280S-2	75	128.2	2960	93.8	93.7	92.4	0.90	242.0	2.5	1.8	2.6	9	94	571.0	0.79186
T2C 280M-2	90	153.4	2960	94.1	94.3	93.2	0.90	290.4	2.5	1.8	2.6	9.5	94	638.0	0.90716
T2C 315S-2	110	187.1	2960	94.3	94.5	93.2	0.90	354.9	2.0	1.4	2.3	6	96	927.0	1.50928
T2C 315M-2	132	223.8	2960	94.6	94.8	93.4	0.90	425.9	2.0	1.4	2.3	6	96	1006.0	1.67962
T2C 315L1-2	160	270.7	2960	94.8	95.0	93.7	0.90	516.2	2.0	1.4	2.3	6	99	1060.0	1.87385
T2C 315L2-2	200	337.6	2960	95	95.3	93.9	0.90	645.3	1.8	1.3	2.3	5.5	99	1130.0	2.13283
T2C 355M1-2	220	371.4	2960	95	95.5	93.8	0.90	709.8	1.8	1.3	2.3	5.5	103	1590.0	2.95585
T2C 355M2-2	250	422.0	2960	95	95.5	93.9	0.90	806.6	1.8	1.3	2.3	5.5	103	1650.0	3.14272
T2C 355L1-2	280	472.7	2960	95	95.6	93.9	0.90	903.4	1.8	1.3	2.3	5.5	103	1715.0	3.47911
T2C 355L2-2	315	531.8	2960	95	95.6	93.9	0.90	1016.3	1.8	1.3	2.3	5.5	103	1780.0	3.85287
T2C 802-4	0.75	1.92	1420	79.6	79.8	77.5	0.71	5.04	2.5	2.1	2.6	5.7	58	16.0	0.00128
T2C 90S-4	1.1	2.75	1430	81.4	81.9	79.1	0.71	7.35	2.5	2.1	2.6	6.1	61	20.0	0.00315
T2C 90L-4	1.5	3.53	1430	82.8	83.4	80.4	0.74	10.02	2.5	2.0	2.6	6.5	61	24.0	0.00411
T2C 100L1-4	2.2	4.71	1430	84.3	85.5	83.6	0.80	14.69	2.2	2.0	2.6	6.6	64	34.0	0.00883
T2C 100L2-4	3	6.33	1435	85.5	85.7	83.9	0.80	19.97	2.2	2.0	3.0	7.6	64	35.0	0.01039
T2C 112M-4	4	8.23	1435	86.6	87.2	85.5	0.81	26.62	2.2	2.0	3.0	7.9	65	45.0	0.01369
T2C 132S-4	5.5	10.91	1440	87.7	89.2	87.1	0.83	36.48	2.2	1.8	3.0	8.8	71	63.0	0.02966
T2C 132M-4	7.5	14.70	1440	88.7	89.8	87.5	0.83	49.74	2.2	1.6	3.0	9	71	77.5	0.03981
T2C 132M2-4	9.2	17.82	1440	88.7	89.9	87.5	0.84	61.01	2.2	1.6	3.0	8.8	71	85.0	0.04700
T2C 160M-4	11	21.30	1440	89.8	91.7	91.0	0.83	72.95	2.5	1.6	2.5	7.1	75	119.0	0.08670
T2C 160L-4	15	27.47	1450	90.6	91.3	90.5	0.87	98.79	2.5	1.6	2.5	8.9	75	146.0	0.11272
T2C 180M-4	18.5	34.05	1450	91.2	91.8	90.8	0.86	121.8	2.5	1.6	2.8	8.6	76	161.0	0.14084
T2C 180L-4	22	39.4	1460	91.6	92.2	91.6	0.88	143.9	2.5	1.6	2.8	8.1	76	176.0	0.16541



# T2C Series IE2 Efficiency Motors Technical Data (400V/50Hz)

Model	Output (kW)	Rated current (A)	Rotation speed (r/min)	Efficiency 100% load (%)	Efficiency 75% load (%)	Efficiency 50% load (%)	Power factor (Φ)	Rated torque (N.m)	T <sub>st</sub> /T <sub>n</sub> (Times)	T <sub>min</sub> /T <sub>n</sub> (Times)	T <sub>max</sub> /T <sub>n</sub> (Times)	I <sub>st</sub> /I <sub>n</sub> (Times)	Noise (dB)	Net weight (kg)	Moment of inertia(kg*m <sup>2</sup> )
T2C 200L-4	30	53.3	1460	92.3	92.8	91.9	0.88	196.2	2.5	2.1	3.0	8.5	79	242.0	0.27306
T2C 225S-4	37	65.5	1470	92.7	93.9	92.6	0.88	240.4	2.2	1.3	2.3	7.6	81	315.0	0.50439
T2C 225M-4	45	78.4	1480	93.1	94.2	92.8	0.89	290.4	2.2	1.3	2.3	7.7	81	340.0	0.59389
T2C 250M-4	55	98.7	1480	93.5	94.4	93.6	0.86	354.9	2.5	1.5	2.5	8.6	83	420.0	0.70950
T2C 280S-4	75	128.0	1480	94	94.9	93.7	0.90	484.0	2.5	2.0	2.5	9	86	580.0	1.59510
T2C 280M-4	90	153.2	1480	94.2	94.9	93.7	0.90	580.7	2.5	2.0	2.5	8.7	86	650.0	1.89187
T2C 315S-4	110	190.9	1480	94.5	94.8	93.2	0.88	709.8	2.0	1.3	2.8	7.4	93	938.0	3.09253
T2C 315M-4	132	226.1	1480	94.7	95.0	93.6	0.89	851.8	2.0	1.3	2.6	7	93	1030.0	3.48345
T2C 315L1-4	160	273.4	1480	94.9	95.0	93.5	0.89	1032.4	2.0	1.3	2.6	6	97	1106.0	3.98390
T2C 315L2-4	200	341.1	1480	95.1	95.3	93.9	0.89	1290.5	2.0	1.3	2.3	6	97	1220.0	4.67201
T2C 355M1-4	220	375.2	1480	95.1	95.9	94.1	0.89	1419.6	1.8	1.3	2.3	5.5	101	1560.0	6.87200
T2C 355M2-4	250	426.3	1480	95.1	95.8	94.0	0.89	1613.2	1.8	1.3	2.3	5.5	101	1600.0	7.63820
T2C 355L1-4	280	477.5	1480	95.1	95.9	94.3	0.89	1806.8	1.8	1.3	2.3	5.5	101	1650.0	8.31927
T2C 355L2-4	315	531.2	1480	95.1	96.0	94.2	0.90	2032.6	1.8	1.3	2.3	5.5	101	1700.0	9.08547
T2C 355L3-4	355	598.7	1480	95.1	96.0	94.2	0.90	2290.7	1.8	1.3	2.3	5.5	101	1780.0	10.10708
T2C 90S-6	0.75	2.23	935	75.9	76.4	73.8	0.64	7.66	2.0	1.8	2.2	5	57	19.6	0.00360
T2C 90L-6	1.1	2.99	935	78.1	78.6	77.6	0.68	11.24	2.0	1.8	2.2	5	57	23.5	0.00536
T2C 100L-6	1.5	3.72	940	79.8	80.2	78.3	0.73	15.24	1.6	1.6	2.2	5	61	32.0	0.00877
T2C 112M-6	2.2	5.39	940	81.8	82.5	79.0	0.72	22.35	2.0	1.8	2.5	6	65	39.0	0.01468
T2C 132S-6	3	6.93	940	83.3	84.0	82.2	0.75	30.48	1.6	1.5	2.2	6	69	54.0	0.03039
T2C 132M1-6	4	9.22	950	84.6	85.1	83.5	0.74	40.21	2.0	1.6	2.5	6	69	65.0	0.03785
T2C 132M2-6	5.5	12.47	950	86	86.8	85.4	0.74	55.29	2.0	1.8	2.5	7	69	66.0	0.04890
T2C 160M-6	7.5	17.5	960	87.2	88.3	86.7	0.71	74.6	2.5	1.8	2.8	9	73	112.0	0.08726
T2C 160L-6	11	23.9	960	88.7	88.6	87.5	0.75	109.4	2.5	1.4	2.8	9	73	132.6	0.12069
T2C 180L-6	15	30.9	960	89.7	90.8	89.3	0.78	149.2	2.5	1.5	2.8	9	73	179.0	0.25695
T2C 200L1-6	18.5	36.9	970	90.4	91.0	89.8	0.80	182.1	2.0	1.4	2.8	9	76	221.4	0.36147
T2C 200L2-6	22	42.6	970	90.9	91.5	90.1	0.82	216.6	2.5	1.8	2.8	10	76	240.6	0.42742
T2C 225M-6	30	55.6	975	91.7	92.3	91.2	0.85	293.8	2.5	1.5	2.2	9	76	335.0	0.67058
T2C 250M-6	37	69.0	975	92.2	93.0	91.8	0.84	362.4	1.8	1.3	2.2	7	78	391.4	0.99243
T2C 280S-6	45	82.4	980	92.7	92.7	91.9	0.85	438.5	2.3	1.4	2.3	8.5	80	514.0	1.78548
T2C 280M1-6	55	99.2	980	93.1	93.2	92.2	0.86	536.0	2.5	1.7	2.8	9	80	584.0	2.20792
T2C 315S-6	75	135.9	980	93.7	94	92.3	0.85	730.9	2.0	1.3	2.3	7	85	807.0	3.25976
T2C 315M-6	90	162.6	980	94	94.6	92.3	0.85	877.0	2.0	1.3	2.3	7	85	913.0	3.90933
T2C 315L1-6	110	198.1	980	94.3	94.8	92.4	0.85	1071.9	2.0	1.3	2.3	7	85	966.0	4.54331
T2C 315L2-6	132	236.9	980	94.6	94.9	92.4	0.85	1286.3	2.0	1.3	2.3	6.5	85	1080.0	5.53956
T2C 355M1-6	160	286.6	980	94.8	94.9	92.5	0.85	1559.2	2.0	1.3	2.3	6.5	92	1537.0	8.97637
T2C 355M2-6	200	357.5	980	95	95	92.6	0.85	1949.0	2.0	1.3	2.3	6.5	92	1720.0	11.00175
T2C 355L-6	250	446.9	980	95	95.2	92.6	0.85	2436.2	2.0	1.3	2.3	6.5	92	1880.0	13.56011

IEC MOTOR

FIRE PUMP MOTOR

GOST MOTOR

NEMA MOTOR

DC MOTOR

EC MOTOR

# T3C Series IE3 Efficiency Motors Technical Data (400V/50Hz)

Model	Output (kW)	Rated current (A)	Rotation speed (r/min)	Efficiency 100% load (%)	Efficiency 75% load (%)	Efficiency 50% load (%)	Power factor (Φ)	Rated torque (N.m)	T <sub>st</sub> /T <sub>n</sub> (Times)	T <sub>min</sub> /T <sub>n</sub> (Times)	T <sub>max</sub> /T <sub>n</sub> (Times)	I <sub>st</sub> /I <sub>n</sub> (Times)	Noisie (dB)	Net weight (kg)	Moment of inertia (kg·m <sup>2</sup> )
T3C 801-2	0.75	1.68	2880	80.7	81.0	76.2	0.80	2.49	2.5	2.1	2.8	7.5	67	15.20	0.00093
T3C 802-2	1.1	2.40	2880	82.7	83.5	81.6	0.80	3.65	2.5	1.8	2.8	8	67	17.10	0.00128
T3C 90S-2	1.5	3.06	2880	84.2	84.9	84.0	0.84	4.97	2.5	1.8	2.8	8.5	72	21.5	0.00224
T3C 90L-2	2.2	4.45	2880	85.9	86.4	84.7	0.83	7.30	2.5	1.8	2.8	8.6	72	24.6	0.00279
T3C 100L-2	3	5.65	2900	87.1	88.5	86.8	0.88	9.88	2.5	2.0	2.8	9.5	76	35.5	0.00496
T3C 112M-2	4	7.28	2910	88.1	88.5	87.1	0.90	13.13	2.5	2.0	2.8	10.5	77	44.5	0.00744
T3C 132S1-2	5.5	10.11	2910	89.2	90.2	88.6	0.88	18.05	2.5	2.0	3.0	10	80	63.2	0.01468
T3C 132S2-2	7.5	13.50	2920	90.1	90.8	89.3	0.89	24.53	2.5	1.5	3.0	10	80	70.2	0.01903
T3C 132M1-2	9.2	16.47	2920	90.6	91.2	89.5	0.89	30.09	2.5	1.5	3.0	10	80	76.8	0.02048
T3C 160M1-2	11	19.34	2930	91.2	93.8	93.0	0.90	35.85	2.5	1.4	3.0	9.5	86	118.0	0.05178
T3C 160M2-2	15	26.18	2940	91.9	93.1	92.9	0.90	48.72	2.5	1.4	3.0	10	86	128.0	0.06206
T3C 160L-2	18.5	31.76	2940	92.4	93.5	93.3	0.91	60.09	2.5	1.4	3.0	9.5	86	144.00	0.07669
T3C 180M-2	22	38.5	2945	92.7	94.1	93.6	0.89	71.34	2.5	1.4	3.0	9	89	183.40	0.09665
T3C 200L1-2	30	52.1	2945	93.3	93.8	93.2	0.89	97.3	2.5	1.5	2.5	8.5	92	247.00	0.17351
T3C 200L2-2	37	64.0	2945	93.7	94.4	94.2	0.89	120.0	2.5	1.5	2.5	8.5	92	268.00	0.20008
T3C 225M-2	45	75.9	2950	94	94.6	94.1	0.91	145.7	2.5	1.4	2.5	8.5	92	369.00	0.34366
T3C 250M-2	55	93.5	2960	94.3	94.5	93.1	0.90	177.4	2.5	1.4	2.6	10	93	428.00	0.44434
T3C 280S-2	75	125.6	2960	94.7	94.9	93.7	0.91	242.0	2.5	1.8	2.6	10	94	587.30	0.82911
T3C 280M-2	90	150.3	2960	95	95.2	94.3	0.91	290.4	2.5	1.8	2.6	10	94	655.00	0.98168
T3C 315S-2	110	185.3	2960	95.2	95.5	94.6	0.90	354.9	2.0	1.4	2.3	7	96	980.00	1.70352
T3C 315M-2	132	221.9	2960	95.4	95.5	94.7	0.90	425.9	2.0	1.4	2.3	7	96	1100.00	1.93860
T3C 315L1-2	160	267.8	2960	95.8	95.8	94.5	0.90	516.2	2.0	1.4	2.3	7	99	1155.00	2.19758
T3C 315L2-2	200	334.8	2960	95.8	96.0	94.7	0.90	645.3	2.0	1.4	2.3	7	99	1260.00	2.55368
T3C 355M1-2	220	394.6	2960	95.8	96.2	94.8	0.84	709.8	2.0	1.5	2.3	6.5	103	1590.00	2.95585
T3C 355M2-2	250	448.4	2960	95.8	96.2	94.8	0.84	806.6	2.0	1.5	2.3	6.5	103	1650.00	3.14272
T3C 355L1-2	280	502.2	2960	95.8	96.2	94.8	0.84	903.4	2.0	1.5	2.3	6.5	103	1715.00	3.47911
T3C 355L2-2	315	558.3	2960	95.8	96.2	94.8	0.85	1016.3	2.0	1.5	2.3	6.5	103	1780.00	3.85287
T3C 802-4	0.75	1.90	1420	82.5	82.8	80.6	0.69	5.04	2.8	2.2	2.8	6.3	58	18.20	0.00155
T3C 90S-4	1.1	2.62	1430	84.1	84.6	83.2	0.72	7.35	2.8	2.2	2.8	6.8	61	23.00	0.00372
T3C 90L-4	1.5	3.63	1430	85.3	86.1	85.2	0.70	10.02	2.8	2.2	3.0	7.3	61	26.30	0.00469
T3C 100L1-4	2.2	4.52	1430	86.7	87.8	85.2	0.81	14.69	2.8	2.2	3.0	8	64	35.50	0.00922
T3C 100L2-4	3	6.33	1435	87.7	88.0	85.9	0.78	19.97	2.5	2.2	3.0	8.2	64	38.50	0.01195
T3C 112M-4	4	7.95	1440	88.6	88.9	87.5	0.82	26.53	2.5	2.2	3.0	8.6	65	47.00	0.01545
T3C 132S-4	5.5	10.67	1440	89.6	90.9	88.9	0.83	36.48	2.5	1.8	3.0	9	71	68.30	0.03397
T3C 132M-4	7.5	14.09	1440	90.4	91.3	91.2	0.85	49.74	2.5	1.6	3.0	9	71	79.00	0.04412
T3C 132M2-4	9.2	17.19	1440	90.9	91.8	90.5	0.85	61.01	2.5	1.6	3.0	9	71	87.50	0.04700
T3C 160M-4	11	20.68	1450	91.4	92.2	91.7	0.84	72.45	2.5	1.3	3.0	10	75	127.00	0.10355
T3C 160L-4	15	27.33	1450	92.1	92.9	92.2	0.86	98.8	2.5	1.3	2.8	8.5	75	160.00	0.13750
T3C 180M-4	18.5	33.5	1460	92.6	93.6	93.0	0.86	121.0	2.5	1.8	3.0	9	76	169.40	0.15530
T3C 180L-4	22	39.2	1460	93	93.7	92.9	0.87	143.9	2.5	1.8	3.0	10	76	196.00	0.19433

# T3C Series IE3 Efficiency Motors Technical Data (400V/50Hz)

Model	Output (kW)	Rated current (A)	Rotation speed (r/min)	Efficiency 100% load (%)	Efficiency 75% load (%)	Efficiency 50% load (%)	Power factor (Φ)	Rated torque (N.m)	T <sub>st</sub> /T <sub>n</sub> (Times)	T <sub>min</sub> /T <sub>n</sub> (Times)	T <sub>max</sub> /T <sub>n</sub> (Times)	I <sub>st</sub> /I <sub>n</sub> (Times)	Nosie (dB)	Net weight (kg)	Moment of inertia (kg·m <sup>2</sup> )
T3C 200L-4	30	57.1	1470	93.6	93.7	93.2	0.81	194.9	2.5	1.8	2.8	9	79	252.00	0.29441
T3C 225S-4	37	65.4	1470	93.9	95.2	94.3	0.87	240.4	2.5	1.4	2.5	9.2	81	324.50	0.57838
T3C 225M-4	45	79.3	1470	94.2	95.2	94.5	0.87	292.3	2.5	1.5	2.5	9	81	352.90	0.65309
T3C 250M-4	55	95.4	1470	94.6	95.2	94.5	0.88	357.3	2.5	1.8	2.5	8.5	83	427.40	0.76504
T3C 280S-4	75	131.0	1480	95	95.1	94.8	0.87	484.0	2.5	1.8	2.8	10	86	673.30	1.99603
T3C 280M-4	90	160.5	1480	95.2	95.1	95.0	0.85	580.7	2.5	1.8	2.8	10	86	692.00	2.18345
T3C 315S-4	110	189.1	1480	95.4	95.7	94.6	0.88	709.8	2.2	1.5	2.6	9	93	1027.00	3.71808
T3C 315M-4	132	226.5	1480	95.6	95.8	95.0	0.88	851.8	2.2	1.5	2.6	9	93	1155.00	4.29667
T3C 315L1-4	160	273.9	1480	95.8	96.0	95.1	0.88	1032.4	2.2	1.5	2.6	9	97	1240.00	5.10990
T3C 315L2-4	200	337.9	1480	96	96.2	95.3	0.89	1290.5	2.2	1.5	2.6	9	97	1400.00	6.17334
T3C 355M1-4	220	371.7	1480	96	96.2	95.3	0.89	1419.6	2.0	1.3	2.3	8	101	1560.00	7.04227
T3C 355M2-4	250	422.3	1480	96	96.3	95.4	0.89	1613.2	2.0	1.3	2.3	8	101	1600.00	7.63820
T3C 355L1-4	280	473.0	1480	96	96.4	95.4	0.89	1806.8	2.0	1.3	2.3	8	101	1650.00	8.31927
T3C 355L2-4	315	532.1	1480	96	96.3	95.5	0.89	2032.6	2.0	1.3	2.3	8	101	1700.00	9.34080
T3C 90S-6	0.75	2.05	935	78.9	79.6	77.2	0.67	7.66	2.0	1.8	2.2	5	57	21.50	0.00435
T3C 90L-6	1.1	2.97	940	81	81.5	80.2	0.66	11.18	2.3	1.8	2.2	5.2	57	25.50	0.00611
T3C 100L-6	1.5	3.55	940	82.5	83.0	81.6	0.74	15.24	2.0	1.7	2.2	5.2	61	33.50	0.00972
T3C 112M-6	2.2	5.38	940	84.3	85.0	83.2	0.70	22.35	2.0	1.8	2.2	6.2	65	40.00	0.01637
T3C 132S-6	3	6.84	940	85.6	86.1	84.5	0.74	30.48	2.0	1.7	2.2	6	69	59.00	0.03223
T3C 132M1-6	4	8.99	950	86.8	87.6	85.2	0.74	40.21	2.0	1.6	2.5	7	69	75.50	0.04338
T3C 132M2-6	5.5	12.71	950	88	88.8	86.9	0.71	55.29	2.3	1.8	2.5	7.5	69	76.30	0.05443
T3C 160M-6	7.5	16.2	960	89.1	90.3	88.0	0.75	74.6	2.3	1.4	2.8	7.5	73	112.00	0.08726
T3C 160L-6	11	23.1	960	90.3	91.2	88.5	0.76	109.4	2.5	1.4	2.8	8.5	73	134.00	0.13544
T3C 180L-6	15	30.1	960	91.2	92.0	90.3	0.79	149.2	2.5	1.4	2.8	8	73	184.50	0.27973
T3C 200L1-6	18.5	36.4	970	91.7	92.3	90.6	0.80	182.1	2.5	1.4	2.8	9.5	76	231.00	0.38345
T3C 200L2-6	22	42.5	970	92.2	93.0	91.3	0.81	216.6	2.5	1.5	2.8	10	76	249.00	0.44941
T3C 225M-6	30	53.0	975	92.9	93.8	90.9	0.88	293.8	1.8	1.5	2.2	7	76	339.00	0.67058
T3C 250M-6	37	67.3	975	93.3	94.0	91.8	0.85	362.4	1.8	1.3	2.0	7	78	399.40	0.99243
T3C 280S-6	45	83.5	980	93.7	94.6	92.7	0.83	438.5	2.5	1.8	2.8	10	80	551.00	2.20274
T3C 280M1-6	55	99.3	980	94.1	95.0	93.4	0.85	536.0	2.5	1.8	2.8	10	80	624.30	2.57302
T3C 315S-6	75	139.6	980	94.6	94.8	93.2	0.82	730.9	2.0	1.3	2.3	7.5	85	860.00	3.80317
T3C 315M-6	90	166.9	980	94.9	95	93.4	0.82	877.0	2.0	1.3	2.3	7.5	85	970.00	4.45274
T3C 315L1-6	110	203.6	980	95.1	95.4	94	0.82	1071.9	2.0	1.3	2.3	7.5	85	1070.00	5.53956
T3C 315L2-6	132	243.6	980	95.4	95.7	94.2	0.82	1286.3	2.0	1.3	2.3	7.5	85	1196.00	6.62638
T3C 355M1-6	160	294.6	980	95.6	95.8	94.3	0.82	1559.2	2.0	1.3	2.3	7.5	92	1537.00	8.97637
T3C 355M2-6	200	367.5	980	95.8	95.8	94.3	0.82	1949.0	2.0	1.3	2.3	7.5	92	1720.00	11.00175
T3C 355L1-6	220	404.2	980	95.8	96	94.2	0.82	2143.9	2.0	1.3	2.3	7.5	92	1800.00	11.64134
T3C 355L-6	250	459.3	980	95.8	96	94.3	0.82	2436.2	2.0	1.3	2.3	7.5	92	1880.00	13.56011

IEC MOTOR

FIRE PUMP MOTOR

GOST MOTOR

NEMA MOTOR

DC MOTOR

EC MOTOR

# MEPS2(Aus) Efficiency Motors Technical Data (400V/50Hz)

Model	Power (kW)	Speed (r/min)	FL Current (A)	Eff (%)	PF (COSΦ)	T <sub>n</sub> (N.M)	I <sub>st</sub> /I <sub>n</sub> (Times)	T <sub>st</sub> /T <sub>n</sub> (Times)	T <sub>min</sub> /T <sub>n</sub> (Times)	T <sub>max</sub> /T <sub>n</sub> (Times)	W.T (kg)	Moment of inertia (kg·m <sup>2</sup> )
2 POLE – 3000 RPM SYNCHRONOUS SPEED 50 Hz												
TCI 801-2	0.75	2848	1.77	80.5	0.76	2.51	5	2.4	2.1	2.8	16.00	0.00093
TCI 802-2	1.1	2846	2.43	82.8	0.79	3.69	5	2.4	2.1	2.9	17.00	0.00128
TCI 90S-2	1.5	2852	3.18	84.1	0.81	5.02	5	2.4	2	2.7	21.00	0.00224
TCI 90L-2	2.2	2845	4.47	85.6	0.83	7.38	5.5	2.4	2.1	2.7	22.00	0.00279
TCI 100L-2	3	2851	6.02	86.7	0.83	10.05	5.5	2.3	2	2.8	35.00	0.00496
TCI 112M-2	4	2910	7.41	87.6	0.89	13.13	6	2.4	2	2.7	47.00	0.00744
TCI 132S1-2	5.5	2905	10.42	88.6	0.86	18.08	6	2.3	2	2.9	61.00	0.01468
TCI 132S2-2	7.5	2910	14.06	89.5	0.86	24.61	6.4	2.3	2	2.8	66.00	0.01903
TCI 160M1-2	11	2920	19.05	90.6	0.92	35.97	6.3	2.4	2.1	3	115.00	0.05384
TCI 160M2-2	15	2918	25.50	91.3	0.93	49.09	6.8	2.4	2.1	3	133.00	0.06617
TCI 160L-2	18.5	2922	31.28	91.8	0.93	60.46	7	2.4	2.1	2.9	148.00	0.07669
TCI 180M-2	22	2930	38.70	92.2	0.89	71.70	7.2	2.3	2	2.8	174.00	0.08888
TCI 200L1-2	30	2925	51.79	92.9	0.9	97.94	7	2.4	2	2.7	233.00	0.17351
TCI 200L2-2	37	2930	63.60	93.3	0.9	120.59	7.2	2.3	2	2.7	248.00	0.19122
TCI 225M-2	45	2930	77.02	93.7	0.9	146.66	7	2.3	2	2.8	321.00	0.28545
TCI 250M-2	55	2940	93.84	94	0.9	178.64	7.8	2.3	1.9	2.7	420.00	0.43328
TCI 280S-2	75	2940	125.75	94.6	0.91	243.60	7.8	2.2	1.9	2.7	568.00	0.90363
TCI 280M-2	90	2940	150.58	94.8	0.91	292.33	7.7	2.2	1.9	2.6	639.00	1.05619
TCI 315S-2	110	2940	185.50	95.1	0.9	357.29	7.7	2	1.8	2.3	929.00	1.70352
TCI 315M-2	132	2940	219.46	95.4	0.91	428.74	7.6	2	1.8	2.3	1008.00	1.93860
TCI 315L1-2	160	2945	268.69	95.5	0.9	518.81	7.8	2	1.8	2.3	1062.00	2.19758
TCI 315L2-2	200	2945	339.64	95.5	0.89	648.51	7.9	2	1.8	2.3	1132.00	2.55368
TCI 355M-2	250	2945	419.83	95.5	0.9	810.64	7.8	2	1.8	2.3	1650.00	3.14272
TCI 355L-2	315	2945	534.93	95.5	0.89	1021.40	7.8	2	1.8	2.3	1780.00	3.85287
4 POLE – 1500 RPM SYNCHRONOUS SPEED 50 Hz												
TCI 802-4	0.75	1420	1.85	82.2	0.71	5.04	5.4	2.3	2.1	2.9	18.00	0.00237
TCI 90S-4	1.1	1425	2.71	83.8	0.7	7.37	5.3	2.3	2.1	2.7	22.00	0.00372
TCI 90L-4	1.5	1420	3.75	85	0.68	10.09	5.5	2.4	2	2.7	26.00	0.00469
TCI 100L1-4	2.2	1430	4.54	86.4	0.81	14.69	6	2.4	2.1	2.9	36.00	0.00922
TCI 100L2-4	3	1430	6.35	87.4	0.78	20.03	6	2.4	2	2.8	37.00	0.01195
TCI 112M-4	4	1435	7.97	88.3	0.82	26.62	6.3	2.5	2	3	51.00	0.01545
TCI 132S-4	5.5	1430	10.85	89.2	0.82	36.73	6.5	2.3	2	2.8	65.00	0.03397
TCI 132M-4	7.5	1430	14.65	90.1	0.82	50.08	6.4	2.3	2	2.7	77.00	0.04412
TCI 160M-4	11	1440	19.60	91	0.89	72.95	6.8	2.5	2.1	2.8	127.00	0.09681
TCI 160L-4	15	1445	26.21	91.8	0.9	99.13	6.7	2.4	2.1	2.9	142.00	0.12402
TCI 180M-4	18.5	1445	32.54	92.2	0.89	122.26	7.2	2.4	2.1	3	160.00	0.16394
TCI 180L-4	22	1460	38.53	92.6	0.89	143.89	7.3	2.3	2	3	185.00	0.18469
TCI 200L-4	30	1460	54.02	93.2	0.86	196.22	7.6	2.4	2	2.7	243.00	0.29441
TCI 225S-4	37	1470	66.34	93.6	0.86	240.36	7.5	2.4	2	2.7	317.00	0.57838
TCI 225M-4	45	1480	79.51	93.9	0.87	290.35	7.3	2.3	2	2.8	341.00	0.69748
TCI 250M-4	55	1480	96.87	94.2	0.87	354.87	7.4	2.4	1.9	2.7	422.00	0.76504
TCI 280S-4	75	1480	131.39	94.7	0.87	483.92	7.5	2.2	1.9	2.6	572.00	1.74089
TCI 280M-4	90	1480	157.17	95	0.87	580.70	7.7	2.2	1.9	2.6	650.00	2.03766
TCI 315S-4	110	1480	185.11	95.3	0.9	709.75	7.8	2	1.8	2.3	949.00	3.71808
TCI 315M-4	132	1480	219.23	95.5	0.91	851.69	7.8	2	1.8	2.3	1049.00	4.29667
TCI 315L1-4	160	1480	265.18	95.7	0.91	1032.36	7.9	2	1.8	2.3	1108.00	5.10990
TCI 315L2-4	200	1480	335.16	95.7	0.9	1290.45	7.7	2	1.8	2.3	1222.00	6.17334
TCI 355M-4	250	1480	423.66	95.7	0.89	1613.06	7.9	2	1.8	2.3	1540.00	7.63820
TCI 355L-4	315	1480	527.88	95.7	0.9	2032.45	7.8	2	1.8	2.3	1780.00	9.34087

# MEPS2(Aus) Efficiency Motors Technical Data (400V/50Hz)

Model	Power (kW)	Speed (r/min)	FL Current (A)	Eff (%)	PF (COSΦ)	T <sub>n</sub> (N.M)	I <sub>s</sub> /I <sub>n</sub> (Times)	T <sub>s</sub> /T <sub>n</sub> (Times)	T <sub>min</sub> /T <sub>n</sub> (Times)	T <sub>max</sub> /T <sub>n</sub> (Times)	W.T (kg)	Moment of inertia (kg·m <sup>2</sup> )
6 POLE – 1000 RPM SYNCHRONOUS SPEED 50 Hz												
TCI 90S-6	0.75	935	1.96	77.7	0.71	7.66	5.3	2.2	2	2.7	20.00	0.00435
TCI 90L-6	1.1	935	2.69	79.9	0.74	11.23	5	2.3	2.1	2.6	29.00	0.00611
TCI 100L-6	1.5	940	3.59	81.5	0.74	15.24	4.9	2.3	2.1	2.7	34.00	0.00972
TCI 112M-6	2.2	940	5.01	83.4	0.76	22.35	5.7	2.3	2.1	2.9	40.00	0.01637
TCI 132S-6	3	940	6.46	84.9	0.79	30.48	6.3	2.4	2.2	2.8	65.00	0.03223
TCI 132M1-6	4	945	8.28	86.1	0.81	40.42	6.2	2.5	2	2.8	67.00	0.04338
TCI 132M2-6	5.5	945	11.21	87.4	0.81	55.58	6.8	2.3	1.9	2.8	68.00	0.05443
TCI 160M-6	7.5	955	16.09	88.5	0.76	74.99	7	2.4	1.9	2.7	122.00	0.10570
TCI 160L-6	11	960	22.96	89.8	0.77	109.42	7.3	2.5	2	2.8	146.00	0.13913
TCI 180L-6	15	960	28.08	90.7	0.85	149.21	7.2	2.3	2.1	2.9	185.00	0.27214
TCI 200L1-6	18.5	965	33.24	91.3	0.88	183.07	6.9	2.4	2.1	3.2	234.00	0.38345
TCI 200L2-6	22	965	39.31	91.8	0.88	217.70	7.3	2.3	1.9	3.1	252.00	0.42742
TCI 225M-6	30	975	54.43	92.5	0.86	293.82	7.4	2.2	1.9	2.7	344.00	0.67058
TCI 250M-6	37	975	66.77	93	0.86	362.38	7.5	2.3	2.1	2.7	404.00	1.15837
TCI 280S-6	45	980	85.76	93.5	0.81	438.49	7.7	2.3	2	2.8	507.00	1.94195
TCI 280M1-6	55	980	104.37	93.9	0.81	535.93	7.7	2.2	1.9	2.7	598.00	2.20792
TCI 315S-6	75	980	128.85	94.4	0.89	730.81	7.9	2.1	1.9	2.5	809.00	3.80317
TCI 315M-6	90	980	152.25	94.8	0.9	876.98	8	2	1.8	2.3	962.00	4.45274
TCI 315L1-6	110	980	185.50	95.1	0.9	1071.86	7.7	2	1.8	2.3	989.00	5.53956
TCI 315L2-6	132	980	224.40	95.4	0.89	1286.23	.8	2	1.8	2.3	1082.00	6.62638
TCI 355M1-6	160	980	265.46	95.6	0.91	1559.07	7.6	2	1.8	2.3	1580.00	8.97637
TCI 355M2-6	200	980	335.51	95.6	0.9	1948.84	7.8	2	1.8	2.3	1720.00	11.00176
TCI 355L-6	250	980	424.10	95.6	0.89	2436.05	7.8	2	1.8	2.3	1880.00	13.56011
8 POLE – 750 RPM SYNCHRONOUS SPEED 50 Hz												
TCI 100L1-8	0.75	690	2.13	73.5	0.69	10.38	4.5	2.2	2	2.5	32.00	0.00925
TCI 100L2-8	1.1	690	3.02	76.3	0.69	15.22	4.5	2.3	2.1	2.6	35.00	0.01114
TCI 112M1-8	1.5	695	3.95	78.4	0.7	20.61	4.8	2.3	2.1	2.6	42.00	0.01722
TCI 132S-8	2.2	700	5.61	80.9	0.7	30.01	5	2.3	2.1	2.7	68.00	0.04513
TCI 132M-8	3	700	7.37	82.7	0.71	40.93	5.1	2.4	2.2	2.7	77.00	0.05259
TCI 160M1-8	4	710	10.88	84.2	0.63	53.80	5.3	2.5	2	2.8	106.00	0.09832
TCI 160M2-8	5.5	710	14.69	85.8	0.63	73.97	5.5	2.3	1.9	2.6	113.00	0.10938
TCI 160L-8	7.5	715	18.53	87.2	0.67	100.17	6	2.4	1.9	2.7	134.00	0.13913
TCI 180L-8	11	720	23.84	88.8	0.75	145.89	6	2.3	2	2.8	177.50	0.27973
TCI 200L-8	15	720	30.84	90	0.78	198.94	6.4	2.2	2	2.9	232.50	0.40544
TCI 2225S-8	18.5	725	38.74	90.7	0.76	243.67	6.4	2.2	2	3.2	315.00	0.63789
TCI 2225M-8	22	725	43.52	91.2	0.8	289.77	7	2.1	1.9	3.1	345.00	0.73596
TCI 250M-8	30	730	61.86	92.1	0.76	392.44	7	2.1	1.9	2.7	421.00	1.24135
TCI 280S-8	37	730	73.86	92.7	0.78	484.01	7.5	2.1	1.8	2.5	612.00	2.30705
TCI 280M1-8	45	735	89.35	93.2	0.78	584.65	7.5	2	1.8	2.5	668.00	2.72950
TCI 315S-8	55	740	107.24	93.7	0.79	709.75	7.5	2	1.8	2.4	918.00	3.89374
TCI 315M-8	75	740	145.16	94.4	0.79	967.83	7.7	2	1.8	2.3	1078.00	5.26785
TCI 315L1-8	90	740	171.47	94.7	0.8	1161.40	7.8	2	1.8	2.2	1158.00	6.26411
TCI 315L2-8	110	745	208.69	95.1	0.8	1409.96	7.8	2	1.8	2.3	1258.00	7.44150
TCI 355M1-8	132	745	237.75	95.4	0.84	1691.96	7.9	2	1.8	2.3	1562.00	10.82687
TCI 355M2-8	160	745	287.28	95.7	0.84	2050.86	7.8	2	1.8	2.3	1657.00	12.26856
TCI 355L-8	200	745	350.75	95.7	0.86	2563.57	7.7	2	1.8	2.3	1817.00	15.02087

IEC MOTOR

FIRE PUMP MOTOR

GOST MOTOR

NEMA MOTOR

DC MOTOR

EC MOTOR

# MEPS2(Aus) Premium Efficiency Motors Technical Data (400V/50Hz)

Model	Power (kW)	Speed (r/min)	FL Current (A)	Eff (%)	PF (COS Φ)	T <sub>n</sub> (N.M)	I <sub>s</sub> /I <sub>n</sub> (Times)	T <sub>s</sub> /T <sub>n</sub> (Times)	T <sub>min</sub> /T <sub>n</sub> (Times)	T <sub>max</sub> /T <sub>n</sub> (Times)
2 POLE – 3000 RPM SYNCHRONOUS SPEED 50 Hz										
TCP 801-2	0.75	2848	1.70	82.9	0.77	2.51	5	2.4	2.1	2.8
TCP 802-2	1.1	2846	2.41	84.5	0.78	3.69	5	2.4	2.1	2.9
TCP 90S-2	1.5	2852	3.18	86.2	0.79	5.02	5	2.4	2	2.7
TCP 90L-2	2.2	2845	4.54	87.5	0.8	7.38	5.5	2.4	2.1	2.7
TCP 100L-2	3	2851	6.04	88.5	0.81	10.05	5.5	2.3	2	2.8
TCP 112M-2	4	2910	7.98	89.3	0.81	13.13	6	2.4	2	2.7
TCP 132S1-2	5.5	2905	10.49	90.1	0.84	18.08	6	2.3	2	2.9
TCP 132S2-2	7.5	2910	14.01	90.9	0.85	24.61	6.4	2.3	2	2.8
TCP 160M1-2	11	2920	19.86	91.9	0.87	35.97	6.3	2.4	2.1	3
TCP 160M2-2	15	2918	26.90	92.5	0.87	49.09	6.8	2.4	2.1	3
TCP 160L-2	18.5	2922	32.30	92.9	0.89	60.46	7	2.4	2.1	2.9
TCP 180M-2	22	2930	38.24	93.3	0.89	71.70	7.2	2.3	2	2.8
TCP 200L1-2	30	2925	51.24	93.9	0.9	97.94	7	2.4	2	2.7
TCP 200L2-2	37	2930	62.99	94.2	0.9	120.59	7.2	2.3	2	2.7
TCP 225M-2	45	2930	75.45	94.6	0.91	146.66	7	2.3	2	2.8
TCP 250M-2	55	2940	91.93	94.9	0.91	178.64	7.8	2.3	1.9	2.7
TCP 280S-2	75	2940	123.34	95.4	0.92	243.60	7.8	2.2	1.9	2.7
TCP 280M-2	90	2940	146.26	95.5	0.93	292.33	7.7	2.2	1.9	2.6
TCP 315S-2	110	2940	184.15	95.8	0.9	357.29	7.7	2	1.8	2.3
TCP 315M-2	132	2040	217.87	96.1	0.91	617.90	7.6	2	1.8	2.3
TCP 315L1-2	160	2945	267.01	96.1	0.9	518.81	7.8	2	1.8	2.3
TCP 315L2-2	200	2945	337.52	96.1	0.89	648.51	7.9	2	1.8	2.3
TCP 355M-2	250	2945	417.21	96.1	0.9	810.64	7.8	2	1.8	2.3
TCP 355L-2	315	2945	531.59	96.1	0.89	1021.40	7.8	2	1.8	2.3
4 POLE – 1500 RPM SYNCHRONOUS SPEED 50 Hz										
TCP 802-4	0.75	1420	1.64	84.5	0.78	5.04	5.4	2.3	2.1	2.9
TCP 90S-4	1.1	1425	2.37	85.9	0.78	7.37	5.3	2.3	2.1	2.7
TCP 90L-4	1.5	1420	3.11	87	0.8	10.09	5.5	2.4	2	2.7
TCP 100L1-4	2.2	1430	4.50	88.2	0.8	14.69	6	2.4	2.1	2.9
TCP 100L2-4	3	1430	6.07	89.1	0.8	20.03	6	2.4	2	2.8
TCP 112M-4	4	1435	7.83	89.9	0.82	26.62	6.3	2.5	2	3
TCP 132S-4	5.5	1430	10.55	90.7	0.83	36.73	6.5	2.3	2	2.8
TCP 132M-4	7.5	1430	13.60	91.5	0.87	50.08	6.4	2.3	2	2.7
TCP 160M-4	11	1440	19.79	92.2	0.87	72.95	6.8	2.5	2.1	2.8
TCP 160L-4	15	1445	26.48	92.9	0.88	99.13	6.7	2.4	2.1	2.9
TCP 180M-4	18.5	1445	32.52	93.3	0.88	122.26	7.2	2.4	2.1	3
TCP 180L-4	22	1460	37.69	93.6	0.9	143.89	7.3	2.3	2	3
TCP 200L-4	30	1460	51.65	94.2	0.89	196.22	7.6	2.4	2	2.7
TCP 225S-4	37	1470	63.50	94.5	0.89	240.36	7.5	2.4	2	2.7
TCP 225M-4	45	1480	76.98	94.8	0.89	290.35	7.3	2.3	2	2.8
TCP 250M-4	55	1480	91.83	95	0.91	354.87	7.4	2.4	1.9	2.7
TCP 280S-4	75	1480	125.62	94.7	0.91	483.92	7.5	2.2	1.9	2.6
TCP 280M-4	90	1480	148.63	95	0.92	580.70	7.7	2.2	1.9	2.6
TCP 315S-4	110	1480	184.73	95.5	0.9	709.75	7.8	2	1.8	2.3
TCP 315M-4	132	1480	218.78	95.7	0.91	851.69	7.8	2	1.8	2.3
TCP 315L1-4	160	1480	264.35	96	0.91	1032.36	7.9	2	1.8	2.3
TCP 315L2-4	200	1480	333.77	96.1	0.9	1290.45	7.7	2	1.8	2.3
TCP 355M-4	250	1480	421.02	96.3	0.89	1613.06	7.9	2	1.8	2.3
TCP 355L-4	315	1480	524.59	96.3	0.9	2032.45	7.8	2	1.8	2.3

# MEPS2(Aus) Premium Efficiency Motors Technical Data (400V/50Hz)

Model	Power (kW)	Speed (r/min)	FL Current (A)	Eff (%)	PF (COS $\phi$ )	T <sub>n</sub> (N.M)	I <sub>a</sub> /I <sub>n</sub> (Times)	T <sub>st</sub> /T <sub>n</sub> (Times)	T <sub>min</sub> /T <sub>n</sub> (Times)	T <sub>max</sub> /T <sub>n</sub> (Times)
6 POLE – 1000 RPM SYNCHRONOUS SPEED 50 Hz										
TCP 90S-6	0.75	935	1.87	80.4	0.72	7.66	5.3	2.2	2	2.7
TCP 90L-6	1.1	935	2.68	82.4	0.72	11.23	5	2.3	2.1	2.6
TCP 100L-6	1.5	940	3.54	83.8	0.73	15.24	4.9	2.3	2.1	2.7
TCP 112M-6	2.2	940	5.09	85.5	0.73	22.35	5.7	2.3	2.1	2.9
TCP 132S-6	3	940	6.83	86.9	0.73	30.48	6.3	2.4	2.2	2.8
TCP 132M1-6	4	945	8.88	87.9	0.74	40.42	6.2	2.5	2	2.8
TCP 132M2-6	5.5	945	11.72	89.1	0.76	55.58	6.8	2.3	1.9	2.8
TCP 160M-6	7.5	955	15.81	90.1	0.76	74.99	7	2.4	1.9	2.7
TCP 160L-6	11	960	22.32	91.2	0.78	109.42	7.3	2.5	2	2.8
TCP 180L-6	15	960	29.79	92	0.79	149.21	7.2	2.3	2.1	2.9
TCP 200L1-6	18.5	965	34.78	92.5	0.83	183.07	6.9	2.4	2.1	3.2
TCP 200L2-6	22	965	41.18	92.9	0.83	217.70	7.3	2.3	1.9	3.1
TCP 225M-6	30	975	55.74	93.6	0.83	293.82	7.4	2.2	1.9	2.7
TCP 250M-6	37	975	66.84	94	0.85	362.38	7.5	2.3	2.1	2.7
TCP 280S-6	45	980	80.01	94.4	0.86	438.49	7.7	2.3	2	2.8
TCP 280M1-6	55	980	96.25	94.8	0.87	535.93	7.7	2.2	1.9	2.7
TCP 315S-6	75	980	127.77	95.2	0.89	730.81	7.9	2.1	1.9	2.5
TCP 315M-6	90	980	151.14	95.5	0.9	876.98	8	2	1.8	2.3
TCP 315L1-6	110	980	184.15	95.8	0.9	1071.86	7.7	2	1.8	2.3
TCP 315L2-6	132	980	222.76	96.1	0.89	1286.23	8	2	1.8	2.3
TCP 355M1-6	160	980	263.80	96.2	0.91	1559.07	7.6	2	1.8	2.3
TCP 355M2-6	200	980	333.42	96.2	0.9	1948.84	7.8	2	1.8	2.3
TCP 355L-6	250	980	421.46	96.2	0.89	2436.05	7.8	2	1.8	2.3
8 POLE – 750 RPM SYNCHRONOUS SPEED 50 Hz										
TCP 100L1-8	0.75	690	2.05	76.5	0.69	10.38	4.5	2.2	2	2.5
TCP 100L2-8	1.1	690	2.91	79.1	0.69	15.22	4.5	2.3	2.1	2.6
TCP 112M1-8	1.5	695	3.82	81	0.7	20.61	4.8	2.3	2.1	2.6
TCP 132M-8	2.2	700	5.45	83.3	0.7	30.01	5	2.3	2.1	2.7
TCP 132M-6	3	700	7.18	84.9	0.71	40.93	5.1	2.4	2.2	2.7
TCP 160M1-8	4	710	9.43	86.2	0.71	53.80	5.3	2.5	2	2.8
TCP 160M2-8	5.5	710	12.57	87.7	0.72	73.97	5.5	2.3	1.9	2.6
TCP 160L-8	7.5	715	16.91	88.9	0.72	100.17	6	2.4	1.9	2.7
TCP 180L-8	11	720	24.09	90.3	0.73	145.89	6	2.3	2	2.8
TCP 200L-8	15	720	32.45	91.4	0.73	198.94	6.4	2.2	2	2.9
TCP 2225S-8	18.5	725	39.22	92	0.74	243.67	6.4	2.2	2	3.2
TCP 2225M-8	22	725	45.82	92.4	0.75	289.77	7	2.1	1.9	3.1
TCP 250M-8	30	730	61.95	93.2	0.75	392.44	7	2.1	1.9	2.7
TCP 280S-8	37	730	74.02	93.7	0.77	484.01	7.5	2.1	1.8	2.5
TCP 280M1-8	45	735	89.55	94.2	0.77	584.65	7.5	2	1.8	2.5
TCP 315S-8	55	740	106.22	94.6	0.79	709.75	7.5	2	1.8	2.4
TCP 315M-8	75	740	143.94	95.2	0.79	967.83	7.7	2	1.8	2.3
TCP 315L1-8	90	740	170.03	95.5	0.8	1161.40	7.8	2	1.8	2.2
TCP 315L2-8	110	745	207.17	95.8	0.8	1409.96	7.8	2	1.8	2.3
TCP 355M1-8	132	745	236.02	96.1	0.84	1691.96	7.9	2	1.8	2.3
TCP 355M2-8	160	745	285.49	96.3	0.84	2050.86	7.8	2	1.8	2.3
TCP 355L-8	200	745	348.57	96.3	0.86	2563.57	7.7	2	1.8	2.3

IEC MOTOR

FIRE PUMP MOTOR

GOST MOTOR

NEMA MOTOR

DC MOTOR

EC MOTOR

# Fire Pump Motors

## STANDARD FEATURES

- ODP TYPE or TEFC TYPE
- Service Factor: 1.15
- Class 'F' insulation for all frames, Class B rise
- Continuous Duty (S1)
- 50°C ambient temperature

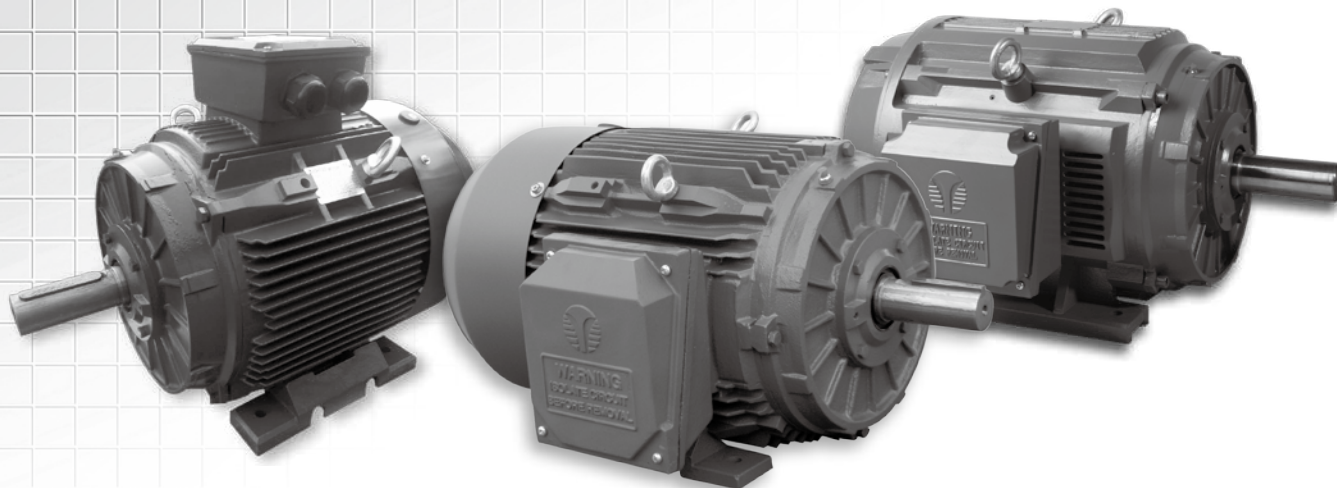

## T Series Motors Dimensional Drawings

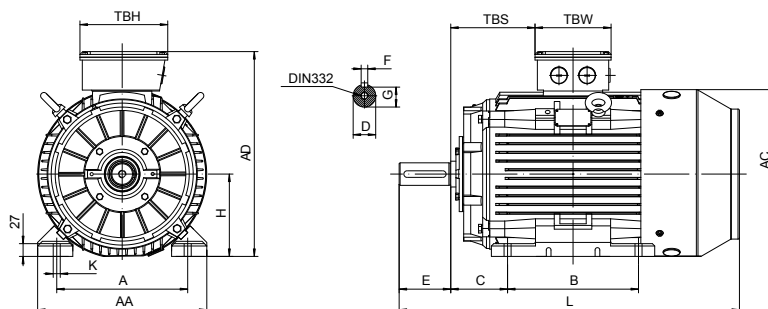

IM B3 Figure 1

## Overall & Installation Dimensions

Frame	Foot Mounting				Shaft					General								
	H	A	B	C	D	E	G	K	AA	AD	HD	AC	L	TBS	TBW	TBH		
80	80	125	100	50	φ19	40	6	15.5	φ9	154	214	134	φ158	290	43	114	114	
90S/L	90	140	100/125	56	φ24	50	8	20	φ10	178	231	141	φ176	320/345	49/61.5	114	114	
100L	100	160	140	63	φ28	60	8	24	φ12	203	251	151	φ199	385	76	114	114	
112M	112	190	140	70	φ28	60	8	24	φ12	231	292	180	φ220	405	73	134	134	
132S/M	132	216	140/178	89	φ38	80	10	33	φ12	263	332	200	φ259	467/505	61.5	134	134	
160M/L	160	254	210/254	108	φ42	110	12	37	φ15	316	404	244	φ313	605/650	91	162	187	
180M/L	180	279	241/279	121	φ48	110	14	42.5	φ15	354	445	265	φ360	687/725	160/180	162	187	
200L	200	318	305	133	φ55	110	16	49	φ19	393	500	300	φ399	768.5	192	186	233	
225S	4,6,8	225	356	286	149	φ60	140	18	53	φ19	440	558	333	φ459	810	199	186	233
	2	225	356	311	149	φ55	110	16	49	φ19	440	558	333	φ459	805	211.5	186	233
225M	4,6,8	225	356	311	149	φ60	140	18	53	φ19	440	558	333	φ459	835	211.5	186	233
	2	250	406	349	168	φ60	140	18	53	φ24	484	616	366	φ506	915	233	218	260
250M	4,6,8	250	406	349	168	φ65	140	18	58	φ24	484	616	366	φ506	915	233	218	260
	2	280	457	368/419	190	φ65	140	18	58	φ24	560	675	395	φ559	984/1035	265/277	218/245	260/280
280S/M	4,6,8	280	457	368/419	190	φ75	140	20	67.5	φ24	560	675	395	φ559	984/1035	265/277	218/245	260/280
	2	315	508	406	216	φ65	140	18	58	φ28	628	825	510	φ680	1205	200	290	350
315S	4,6,8	315	508	406	216	φ80	170	22	71	φ28	628	825	510	φ680	1235	200	290	350
	2	315	508	457/508	216	φ65	140	18	58	φ28	628	825	510	φ680	1355	200	290	350
315M/L	4,6,8	315	508	457/508	216	φ80	170	22	71	φ28	628	825	510	φ680	1385	200	290	350
	2	355	610	560/630	254	φ75	140	20	67.5	φ28	740	1010	655	φ820	1495	140	330	380
355M/L	4,6,8	355	610	560/630	254	φ95	170	25	86	φ28	740	1010	655	φ820	1525	140	330	380
	4,6,8	355	610	560/630	254	φ100	210	28	90	φ28	740	1010	655	φ820	1565	140	330	380





# Serie Fire Pump Motors' Main Performance Parameters (IEC)

Serial NO.	Model NO.	Volts	Output (kW)	Output (HP)	Hz /DC	Locked current A(standard) 400V	Locked torque multiple (standard)	Maximum torque multiple (standard)	Minimum torque multiple (standard)	INS class	RPM	The test environment temperature
1	T 801-2	380-415V	0.75	1.0	50	19.0	175	250	120	F	2848	50°C
2	T 802-2	380-415V	1.1	1.5	50	25.7	175	250	120	F	2846	50°C
3	T 803-2	380-415V	1.5	2.0	50	32.3	170	240	120	F	2852	50°C
4	T 90S-2	380-415V	1.5	2.0	50	32.3	170	240	120	F	2852	50°C
5	T 90L1-2	380-415V	2.2	3.0	50	40.9	160	230	110	F	2845	50°C
6	T 90L2-2	380-415V	3	4.0	50	49.4	155	220	105	F	2851	50°C
7	T 100L-2	380-415V	3	4.0	50	49.4	155	220	105	F	2851	50°C
8	T 100L2-2	380-415V	4	5.5	50	61.8	145	215	105	F	2910	50°C
9	T 112M-2	380-415V	4	5.5	50	61.8	145	215	105	F	2910	50°C
10	T 112L-2	380-415V	5.5	7.5	50	79.8	140	200	100	F	2905	50°C
11	T 132S1-2	380-415V	5.5	7.5	50	79.8	140	200	100	F	2905	50°C
12	T 132S2-2	380-415V	7.5	10.0	50	101.7	135	200	100	F	2910	50°C
13	T 132M1-2	380-415V	9.2	12.0	50	118.8	130	200	100	F	2910	50°C
14	T 132M2-2	380-415V	11	15.0	50	146.3	130	200	100	F	2920	50°C
15	T 160M1-2	380-415V	11	15.0	50	146.3	130	200	100	F	2920	50°C
16	T 160M2-2	380-415V	15	20.0	50	184.3	130	200	100	F	2918	50°C
17	T 160L-2	380-415V	18.5	25.0	50	230.9	130	200	100	F	2922	50°C
18	T 180M-2	380-415V	22	30.0	50	274.6	130	200	100	F	2930	50°C
19	T 200L1-2	380-415V	30	40.0	50	367.7	125	200	100	F	2925	50°C
20	T 200L2-2	380-415V	37	50.0	50	457.9	120	200	100	F	2930	50°C
21	T 225M-2	380-415V	45	60.0	50	549.1	120	200	100	F	2930	50°C
22	T 250M-2	380-415V	55	75.0	50	685.9	105	200	95	F	2940	50°C
23	T 280S-2	380-415V	75	100.0	50	916.8	105	200	95	F	2940	50°C
24	T 280M-2	380-415V	90	125.0	50	1146.7	100	200	90	F	2940	50°C
25	T 315S-2	380-415V	110	150.0	50	1369.0	100	200	90	F	2940	50°C
26	T 315M-2	380-415V	132	175.0	50	1599.8	100	200	90	F	2940	50°C
27	T 315L1 -2	380-415V	160	215.0	50	1900.0	90	175	65	F	2945	50°C
28	T 315L2 -2	380-415V	200	270.0	50	2636.3	70	175	65	F	2945	50°C
29	T 355M-2	380-415V	250	330.0	50	3125.5	70	175	65	F	2945	50°C
30	T 355L-2	380-415V	315	420.0	50	4075.5	70	175	65	F	2945	50°C
31	T 802-4	380-415V	0.75	1.0	50	19.0	275	300	190	F	1420	50°C
32	T 803-4	380-415V	1.1	1.5	50	25.7	250	280	175	F	1425	50°C
33	T 90S-4	380-415V	1.1	1.5	50	25.7	250	280	175	F	1425	50°C
34	T 90L-4	380-415V	1.5	2.0	50	32.3	235	270	165	F	1420	50°C
35	T 90L2-4	380-415V	2.2	3.0	50	40.9	215	250	150	F	1430	50°C
36	T 100L1-4	380-415V	2.2	3.0	50	40.9	215	250	150	F	1430	50°C
37	T 100L2-4	380-415V	3	4.0	50	49.4	200	230	140	F	1430	50°C
38	T 100L3-4	380-415V	4	5.5	50	61.8	180	225	130	F	1435	50°C
39	T 112M-4	380-415V	4	5.5	50	61.8	180	225	130	F	1435	50°C
40	T 112L-4	380-415V	5.5	7.5	50	79.8	175	215	120	F	1430	50°C
41	T 132S-4	380-415V	5.5	7.5	50	79.8	175	215	120	F	1430	50°C
42	T 132M-4	380-415V	7.5	10.0	50	101.7	165	200	115	F	1430	50°C
43	T 132L1-4	380-415V	9.2	12.0	50	118.8	160	200	115	F	1430	50°C
44	T 132L2-4	380-415V	11	15.0	50	146.3	160	200	110	F	1440	50°C
45	T 160M-4	380-415V	11	15.0	50	146.3	160	200	110	F	1440	50°C
46	T 160L-4	380-415V	15	20.0	50	184.3	150	200	105	F	1445	50°C
47	T 180M-4	380-415V	18.5	25.0	50	230.9	150	200	105	F	1445	50°C
48	T 180L-4	380-415V	22	30.0	50	274.6	150	200	105	F	1460	50°C
49	T 200L-4	380-415V	30	40.0	50	367.7	140	200	100	F	1460	50°C
50	T 225S-4	380-415V	37	50.0	50	457.9	140	200	100	F	1470	50°C

IEC MOTOR

FIRE PUMP MOTOR

GOST MOTOR

NEMA MOTOR

DC MOTOR

EC MOTOR

**T****Serie Fire Pump Motors' Main Performance Parameters (IEC)**

Serial NO.	Model NO.	Volts	Output (kW)	Output (HP)	Hz /DC	Locked current A(standard) 400V	Locked torque multiple (standard)	Maximum torque multiple (standard)	Minimum torque multiple (standard)	INS class	RPM	The test environment temperature
51	T 225M-4	380-415V	45	60.0	50	549.1	140	200	100	F	1480	50°C
52	T 250M-4	380-415V	55	75.0	50	685.9	140	200	100	F	1480	50°C
53	T 280S-4	380-415V	75	100.0	50	916.8	125	200	100	F	1480	50°C
54	T 280M-4	380-415V	90	125.0	50	1146.7	110	200	100	F	1480	50°C
55	T 315S-4	380-415V	110	150.0	50	1369.0	110	200	100	F	1480	50°C
56	T 315M-4	380-415V	132	175.0	50	1599.8	100	200	90	F	1480	50°C
57	T 315L1-4	380-415V	160	215.0	50	1900.0	90	175	75	F	1480	50°C
58	T 315L2-4	380-415V	200	270.0	50	2636.3	80	175	75	F	1480	50°C
59	T 355M1-4	380-415V	220	300.0	50	2874.7	80	175	75	F	1480	50°C
60	T 355M2-4	380-415V	250	330.0	50	3125.5	80	175	75	F	1480	50°C
61	T 355L1-4	380-415V	280	375.0	50	3604.3	80	175	75	F	1480	50°C
62	T 355L2-4	380-415V	315	420.0	50	4075.5	80	175	75	F	1480	50°C
63	T 355L3-4	380-415V	355	475.0	50	4563.8	80	175	75	F	1480	50°C
64	T 803-6	380-415V	0.75	1.0	50	19.0	170	265	120	F	935	50°C
65	T 90S-6	380-415V	0.75	1.0	50	19.0	170	265	120	F	935	50°C
66	T 90L-6	380-415V	1.1	1.5	50	25.7	165	250	115	F	935	50°C
67	T 100L-6	380-415V	1.5	2.0	50	32.3	160	240	110	F	940	50°C
68	T 112M-6	380-415V	2.2	3.0	50	40.9	155	230	110	F	940	50°C
69	T 112M1-6	380-415V	3	4.0	50	49.4	150	220	105	F	940	50°C
70	T 112M2-6	380-415V	4	5.5	50	61.8	150	215	105	F	940	50°C
71	T 132S-6	380-415V	3	4.0	50	49.4	150	220	105	F	940	50°C
72	T 132M1-6	380-415V	4	5.5	50	61.8	150	215	105	F	945	50°C
73	T 132M2-6	380-415V	5.5	7.5	50	79.8	150	205	105	F	945	50°C
74	T 132M3-6	380-415V	7.5	10.0	50	101.7	150	200	105	F	945	50°C
75	T 160M-6	380-415V	7.5	10.0	50	101.7	150	200	105	F	955	50°C
76	T 160L-6	380-415V	11	15.0	50	146.3	140	200	100	F	960	50°C
77	T 180L-6	380-415V	15	20.0	50	184.3	135	200	100	F	960	50°C
78	T 200L1-6	380-415V	18.5	25.0	50	230.9	135	200	100	F	965	50°C
79	T 200L2-6	380-415V	22	30.0	50	274.6	135	200	100	F	965	50°C
80	T 225M-6	380-415V	30	40.0	50	367.7	135	200	100	F	975	50°C
81	T 250M-6	380-415V	37	50.0	50	457.9	135	200	100	F	975	50°C
82	T 280S-6	380-415V	45	60.0	50	549.1	135	200	100	F	980	50°C
83	T 280M-6	380-415V	55	75.0	50	685.9	135	200	100	F	980	50°C
84	T 315S-6	380-415V	75	100.0	50	916.8	125	200	100	F	980	50°C
85	T 315M-6	380-415V	90	125.0	50	1146.7	125	200	100	F	980	50°C
86	T 315L1-6	380-415V	110	150.0	50	1369.0	120	200	100	F	980	50°C
87	T 315L2-6	380-415V	132	175.0	50	1599.8	120	200	100	F	980	50°C
88	T 355M1-6	380-415V	160	215.0	50	1900.0	100	175	90	F	980	50°C
89	T 355M2-6	380-415V	200	270.0	50	2636.3	100	175	90	F	980	50°C
90	T 355L1-6	380-415V	220	300.0	50	2874.7	100	175	90	F	980	50°C
91	T 355L2-6	380-415V	250	330.0	50	3125.5	100	175	90	F	980	50°C